

CompTIA.N10-007.v2022-12-22.q503

Exam Code:	N10-007
Exam Name:	CompTIA Network+ Certification Exam
Certification Provider:	CompTIA
Free Question Number:	503
Version:	v2022-12-22
# of views:	4307
# of Questions views:	5030
https://www.freeqas.com/qa/CompTIA/N10-007/CompTIA.N10-007.v2022-12-22.q503.html	

NEW QUESTION: 1

According to the OSI model, at which of the following layers is data encapsulated into a packet?

- A. Layer 2
- B. Layer 6
- C. Layer 3
- D. Layer 4
- E. Layer 5

Answer: C ([LEAVE A REPLY](#))

NEW QUESTION: 2

You have been tasked with testing a CAT5e cable. A summary of the test results can be found on the screen.

Step 1: Select the tool that was used to create the cable test results.

Step 2: Interpret the test results and select the option that explains the results. After you are done with your analysis, click the 'Submit Cable Test Analysis' button.

Cable Crimp

Instructions: You have determined that the original crimp is faulty using the T568B cabling standard. Drag the appropriate tool to the RJ-45 Connector. When you are finished, click the Done button.

Question:
You have been tasked with testing a CAT5e cable. A summary of the test results can be found on the screen.

Step 1: Select the tool that was used to create the cable test results.

Step 2: Interpret the test results and select the option that explains the results. After you are done with your analysis, click the 'Submit Cable Test Analysis' button.

This window can be resized. ATA Simulatio



RJ-45 Connector

1	Yellow/Black
2	Yellow
3	Green/White
4	Blue
5	Blue/White
6	Green
7	Brown/White
8	Brown



CompTIA

Cable Test

Step 1: Select the tool that was used to create the cable test results.

Cable Test Result

1, 2	Open	7ft
3, 6	Short	7ft
4, 5	Open	7ft
7, 8	Open	7ft

➔

Tool Choices

- Crimper
- Cable Certifier
- Multimeter
- Punch Down Tool
- Protocol Analyzer
- OTDR
- Toner Probe

CompTIA

Answer:

CompTIA

Cable Test

Step 1: Select the tool that was used to create the cable test results.

Cable Test Result		
1, 2	Open	7ft
3, 6	Short	7ft
4, 5	Open	7ft
7, 8	Open	7ft

Tool Choices	
<input type="checkbox"/>	Crimper
<input checked="" type="checkbox"/>	Cable Certifier
<input type="checkbox"/>	Multimeter
<input type="checkbox"/>	Punch Down Tool
<input type="checkbox"/>	Protocol Analyzer
<input type="checkbox"/>	OTDR
<input type="checkbox"/>	Toner Probe

Explanation:

A Cable Certifier provides "Pass" or "Fail" information in accordance with industry standards but can also show detailed information when a "Fail" occurs. This includes shorts, the wire pairs involved and the distance to the short. When a short is identified, at the full length of the cable it means the cable has not been crimped correctly.

NEW QUESTION: 3

Which of the following BEST describes an exploit?

- A. A privilege escalation script
- B. A SNMPv1 private community
- C. An open mail relay server
- D. A router with default credentials

Answer: ([SHOW ANSWER](#))

NEW QUESTION: 4

A network technician travels to a remote office to set up a new SOHO for the company. Wireless networking should be used at the remote office. The network technician sets up all the related wireless network equipment, and the last step is to connect the users' devices to the company

network. To complete this step, which of the following should be used to secure the remote network location?

- A. WPA2/WPA
- B. Open access
- C. Host-based firewalls
- D. Port filtering

Answer: A ([LEAVE A REPLY](#))

NEW QUESTION: 5

A wireless network administrator has been advised that some company devices can only connect to wireless networks that employ TKIP stream cipher encryption. The administrator has changed the security settings to allow these devices to connect. Which of the following wireless security methods has the administrator configured?

- A. Captive portal
- B. WEP
- C. WPA
- D. MAC filtering

Answer: C ([LEAVE A REPLY](#))

NEW QUESTION: 6

A network engineer is troubleshooting an issue after installing a new switch in the datacenter. The cables are not labeled, and the engineer has forgotten into which port the switch plugged. Which of the following should the engineer review to find out this information?

- A. Performance baseline documentation
- B. Change management documentation
- C. Logical diagram
- D. Physical diagram

Answer: D ([LEAVE A REPLY](#))

NEW QUESTION: 7

Your company recently purchased a new building down the street from the existing office. For each of the tasks below, select the appropriate antenna type and encryption object for all wireless access point (AP).

1. Create an encrypted wireless connection between the two buildings that BEST controls signal propagation, while maximizing security.
2. Restrict the wireless signal generated by the access points (APs) inside Building 1, so that it minimizes broadcast beyond the building.
3. Maximize wireless coverage inside Building 1.
4. Building 1's internal wireless network is for visitors only and must not require any special configuration on the visitor's device to connect.

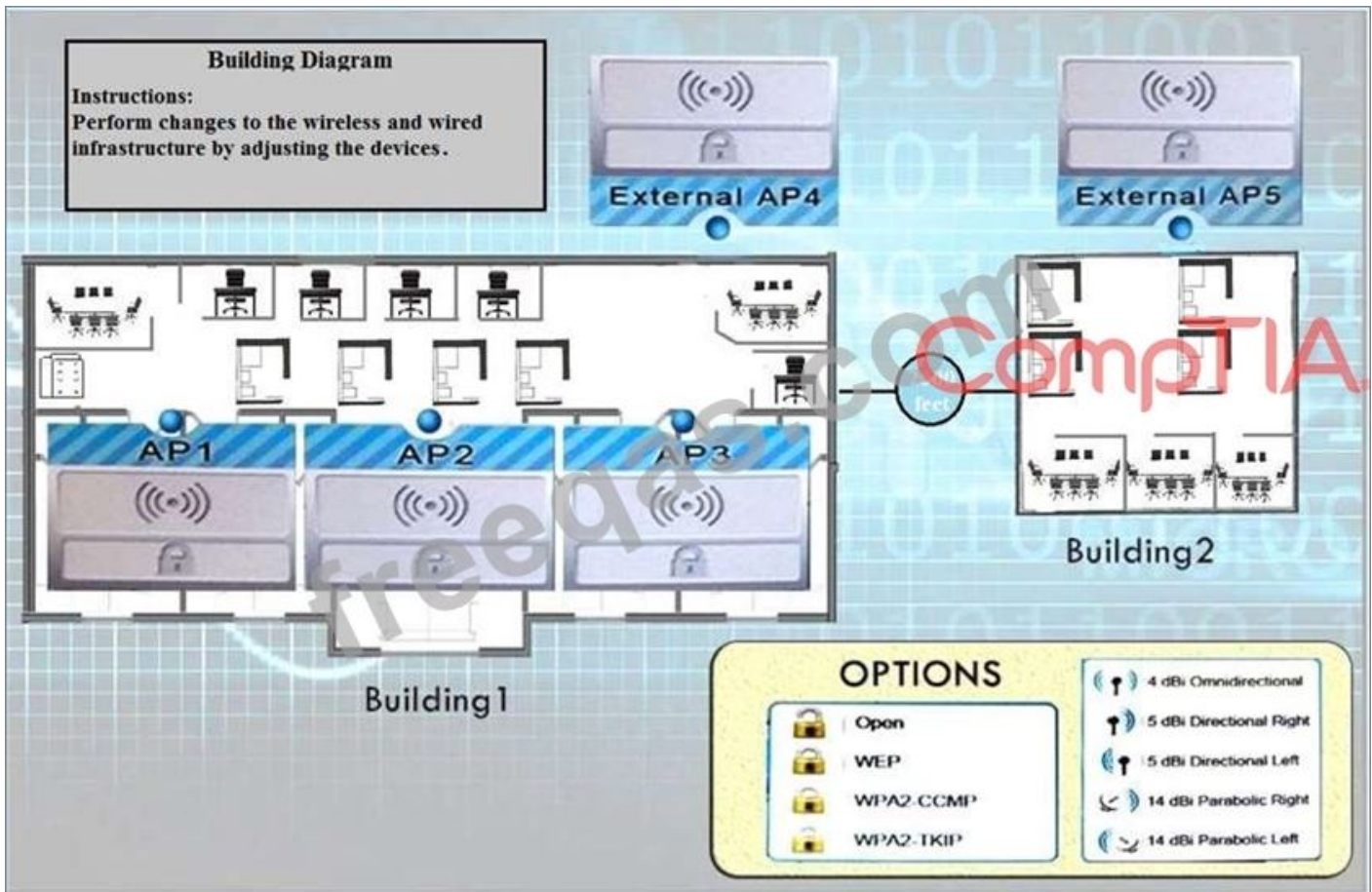

Instructions: When you have completed the SIMULATION, select the Done button to submit.

Answer:

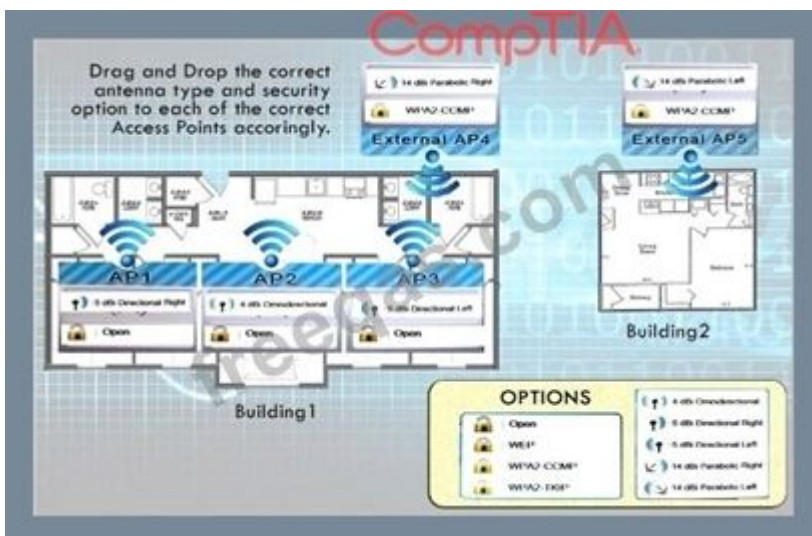

NEW QUESTION: 8

A company requires a network storage solution that allows for the use of OS-specific credentials and permissions. The company purchases a SOHO solution, which includes support for SMB, iSCSI, FTP, Telnet, and NFS natively out of the box. Which of the following should be done FIRST?

- A. Verify user credentials.
- B. Disable unnecessary services.

- C. Hash files that will be stored.
- D. Generate new keys and certificates.

Answer: B ([LEAVE A REPLY](#))

NEW QUESTION: 9

Which of the following are DNS record type? (Select THREE).

- A. LDAP
- B. TTL
- C. CNAME
- D. DHCP
- E. SSH
- F. SRV
- G. NTP
- H. PTR

Answer: ([SHOW ANSWER](#))

NEW QUESTION: 10

An office network consists of one two-port router connected to a 12-port switch. A four-port hub is also connected to the switch. On this particular network, which of the following is the number of collision domains that exist?

- A. 15
- B. 3
- C. 14
- D. 12
- E. 13

Answer: C ([LEAVE A REPLY](#))

NEW QUESTION: 11

Workstations are unable to access the Internet after a recent power outage. Configure the appropriate devices to ensure ALL workstations have Internet connectivity.

Instructions: All ports can be enabled (green) or disabled (red). When you have completed the simulation please select the Done button.

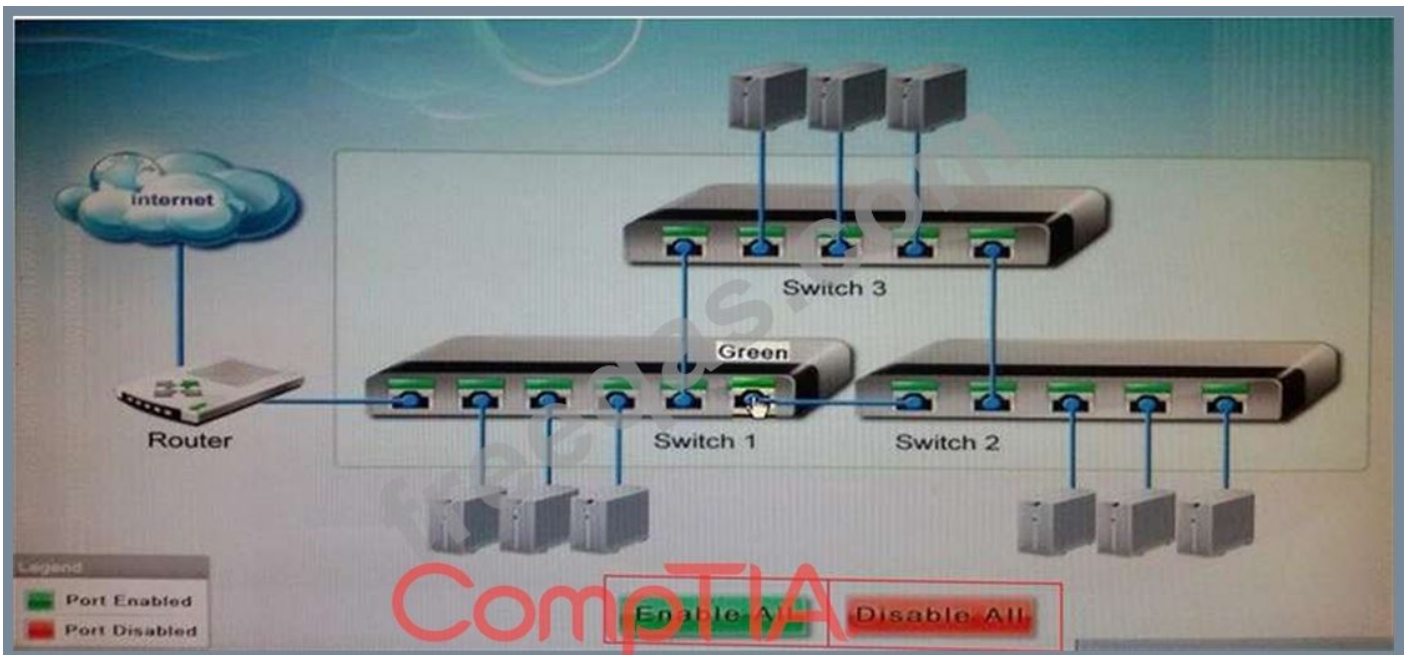

Answer:

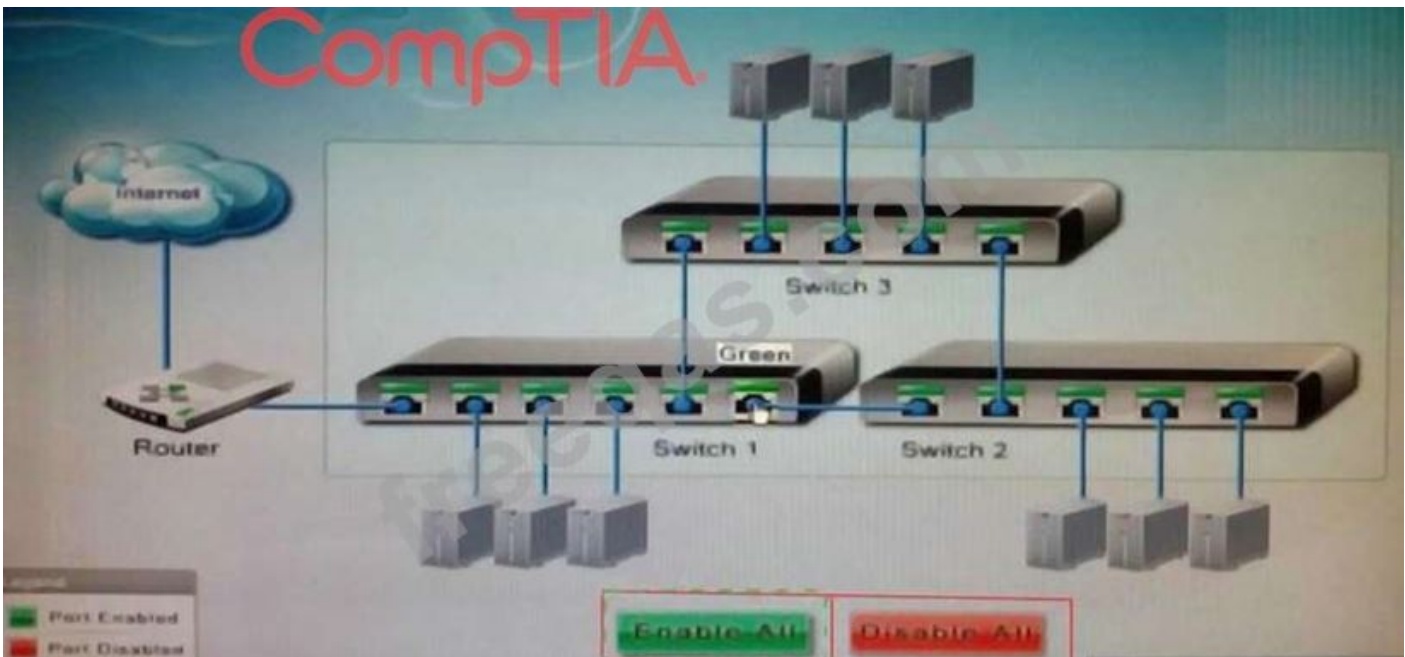

Explanation

All ports should be enabled.

NEW QUESTION: 12

Ann, a network technician, has just installed a fiber switch in a datacenter. To run the fiber cabling, Ann plans the cable route over the top of the rack using the cable trays, down to the switch, coiling up any excess cable. As Ann configures the switch, she notices several messages in the logging buffer stating the receive signal of the SFP is too weak. Which of the following is MOST likely the cause of the errors in the logging buffer?

- A. Bend radius exceeded
- B. Fiber cable mismatch
- C. Fiber type mismatch

D. Bad fiber switch

Answer: A ([LEAVE A REPLY](#))

Explanation/Reference:

NEW QUESTION: 13

A company runs Linux servers in its own datacenter and also on a popular public cloud service provider. The servers hosted by the cloud provider can only be accessed with proper authorization and are only accessed by the company's datacenter. Which of the following BEST describes the type of cloud architecture being used? (Select TWO).

- A. PaaS
- B. Private
- C. Hybrid
- D. IaaS
- E. Public
- F. SaaS

Answer: ([SHOW ANSWER](#))

NEW QUESTION: 14

A network administrator is configuring the 172.16.40.0/22 network for a new building. Which of the following is the number of hosts that will be supported on this network?

- A. 1022
- B. 512
- C. 2048
- D. 2046
- E. 510
- F. 1024

Answer: A ([LEAVE A REPLY](#))

NEW QUESTION: 15

A network technician receives the following command output from a Linux-based machine:

```
ABCDEG.com 430 IN mx mx1.ABCDEG.com
ABCDEG.com 5 IN mx mx2.ABCDEG.com
ABCDEG.com 430 IN mx mx10.ABCDEG.com
ABCDEG.com 521 IN NS ns1.ABCDEG.com
ABCDEG.com 521 IN NS ns3.ABCDEG.com
ABCDEG.com 521 IN NS ns2.ABCDEG.com
ABCDEG.com 521 IN NS ns4.ABCDEG.com
```

Which of the following commands did the network technician run?

- A. netstat -a ACDEG.com
- B. NMAP -t ABCDEG.com
- C. dig -t ANY ABCDEG.com
- D. iptables -f ABCDEG.com

Answer: C ([LEAVE A REPLY](#))

NEW QUESTION: 16

A network technician receives a call from a user who is experiencing network connectivity issues. The network technician questions the user and learns the user brought in a personal wired router to use multiple computers and connect to the network. Which of the following has the user MOST likely introduced to the network?

- A. Rogue DHCP server
- B. Evil twin
- C. VLAN mismatch
- D. Honeypot

Answer: A ([LEAVE A REPLY](#))

Explanation/Reference:

Valid N10-007 Dumps shared by PrepPdf.com for Helping Passing N10-007 Exam!
PrepPdf.com now offer the **newest N10-007 exam dumps**, the PrepPdf.com N10-007 exam **questions have been updated** and **answers have been corrected** get the **newest** PrepPdf.com N10-007 dumps with Test Engine here:
<https://www.preppdf.com/CompTIA/N10-007-prepaway-exam-dumps.html> (**690** Q&As Dumps, **40%OFF** Special Discount: **Exam-Tests**)

NEW QUESTION: 17

A network technician has purchased a 10GBase-T switch and wishes to connect it to 30 computers with 10G network cards. The computers are 225ft (69m) away, and all need to establish a 10Gbps connection to meet business requirements. To minimize costs while still meeting these requirements, which of the following cable types should the technician choose?

- A. Cat 5e
- B. Cat 6
- C. Cat 6a
- D. Cat 7

Answer: A ([LEAVE A REPLY](#))

NEW QUESTION: 18

An administrator is redesigning a company's network and wants to reduce the amount of hardware needed.

Currently, all VLAN routing goes out a single switch interface to a router.

Which of the following would reduce the number of devices in this configuration?

- A. Next-generation firewall
- B. Multilayer switch
- C. Bridge

D. Switch

Answer: ([SHOW ANSWER](#))

NEW QUESTION: 19

A technician is investigating an issue related to a single host that is unable to access the Internet. The technician records the following information: Host IP 169.254.1.10. The network IP address range on the DHCP server is 10.10.5.2-10.10.5.250 with a default gateway 10.10.5.1 and a DNS of 8.8.8.8. Which of the following should the technician perform to troubleshoot the issue?

- A. Configure the DNS address in the DHCP scope to a 10.10.5.0/24 address.
- B. Change the IP scope on the DHCP server to a public IP address range.
- C. Verify the host has physical connectivity and is on the correct VLAN.
- D. Perform a traceroute command to identify the router that is not functioning.

Answer: C ([LEAVE A REPLY](#))

NEW QUESTION: 20

Which of the following methods for network performance optimization is used to distribute traffic among similar devices?

- A. Fault tolerance
- B. Proxy server
- C. Load balancing
- D. QoS

Answer: C ([LEAVE A REPLY](#))

NEW QUESTION: 21

The software that allows a machine to run multiple operating systems at once is called the:

- A. Partition manager
- B. Server manager
- C. Boot loader
- D. Hypervisor

Answer: ([SHOW ANSWER](#))

NEW QUESTION: 22

A technician is working on a Linux VM in a lab environment to become more familiar with the operating system.

The technician has configured a basic website and wants to allow access to it from a different machine on the local network. Which of the following should the technician do so other machines can connect?

- A. Employ arp to configure a new route.
- B. Add access rules in iptables.
- C. Allow communication through ifconfig.
- D. Use netstat to open necessary ports.

Answer: B ([LEAVE A REPLY](#))

NEW QUESTION: 23

A network engineer is designing a wireless network that uses multiple access point for complete coverage.

Which of the following channel selections would result in the LEAST amount of interference between each access point?

- A. Adjacent access point should be assigned channels 1, 6, and 11 with a 20MHz channel width.
- B. Adjacent access points should be assigned channels 2,6, and 10 with a 20MHz channel width.
- C. Adjacent access points should be assigned channels 7 and 11 with a 40MHz channel width.
- D. Adjacent access points should be assigned channels 8 and 11 with a 40MHz channel width.

Answer: A ([LEAVE A REPLY](#))

<http://www.windowsnetworking.com/articles-tutorials/wireless-networking/tips-assigning-wi-fi-channels.html>

NEW QUESTION: 24

customer called the help desk to report general slowness on the network. According to the customer, the network is entirely unusable for a video conference that is scheduled for that morning. Which of the following should the network administrator do FIRST to investigate the issue?

- A. Remotely restart the local routing and switching equipment.
- B. Instruct the customer to reinstall the video conferencing software.
- C. Contact the software vendor for a server status update
- D. Reference the baseline to determine the expected performance.

Answer: D ([LEAVE A REPLY](#))

NEW QUESTION: 25

A network technician receives reports indicating some users are unable to gain access to any network resources. During troubleshooting, the technician discovers the workstations have an IP address of

169.254.x.x. Which of the following is the MOST likely cause?

- A. Exhausted dynamic scope
- B. Expired IP address
- C. Misconfigured VLSM
- D. Rogue DHCP server

Answer: A ([LEAVE A REPLY](#))

NEW QUESTION: 26

A network administrator is troubleshooting a connectivity issue to a remote switch. The administrator suspects the settings on the switch have been changed, causing the issue. Which of the following should the administrator reference to confirm the change?

- A. Network SOP
- B. Rack diagrams
- C. Inventory management
- D. Configuration baseline

Answer: D ([LEAVE A REPLY](#))

NEW QUESTION: 27

A network manager is reviewing the IP addressing scheme a junior technician created for a new department that has 102 hosts. Using the smallest network possible, which of the following is the correct subnet mask for the new department?

- A. 255.255.255.255.192
- B. 255.255.128.0
- C. 255.255.255.128.
- D. 255.255.192.0

Answer: C ([LEAVE A REPLY](#))

NEW QUESTION: 28

Given the table below:

Host Name	IP Address
Host A	192.168.10.22/24
Host B	192.168.10.23/24
Host C	192.168.11.125/24
Host D	192.168.11.53/24
Host E	192.168.5.15/24

Which of the following addresses can Host E send a packet to that will reach Hosts C and D, but not Hosts A and B?

- A. 192.168.5.1
- B. 192.168.11.255
- C. 192.168.11.0
- D. 192.168.255.255

Answer: B ([LEAVE A REPLY](#))

NEW QUESTION: 29

A technician has installed an older IP camera as a temporary replacement for a recently failed newer one.

The technician notices that when the camera's video stream is off, the ping roundtrip time between the

camera and the network DVR is consistently less than 1ms without dropped packets. When the camera

video stream is turned on, the ping roundtrip time increases dramatically, and network communication is

slow and inconsistent. Which of the following is MOST likely the issue in this scenario?

- A. VLAN mismatch
- B. Cat 6 RX/TX reversed
- C. Damaged cable
- D. Duplex mismatch

Answer: D ([LEAVE A REPLY](#))

NEW QUESTION: 30

Ann, a new employee within a department, cannot print to any of the printers in the department or access

any of the resources that others can. However, she can access the Internet. The network engineer has

confirmed that Ann's account has been set up the same as the others. There are no access lists restricting

Ann's access. Which of the following could be the issue for this lack of access?

- A. Spanning tree blocked ports
- B. VLAN mismatch
- C. Duplex/speed mismatch
- D. DHCP server issue
- E. DNS server issue

Answer: ([SHOW ANSWER](#))

NEW QUESTION: 31

Corporate headquarters provided your office a portion of their class B subnet to use at a new office location.

Range Given: 172.30.232.0/24

Sales 57 devices

HR 23 devices

IT 12 devices

Finance 32 devices

Marketing 9 devices

INSTRUCTIONS

Allocate the minimum number of addresses (using CIDR notation) needed to accommodate each department.

After accommodating each department, identify the unused portion of the subnet by responding to the question on the graphic.

All drop downs must be filled.

If at any time you would like to bring back the initial state of the simulation, please click the Reset All button.

Network Subnet Diagram

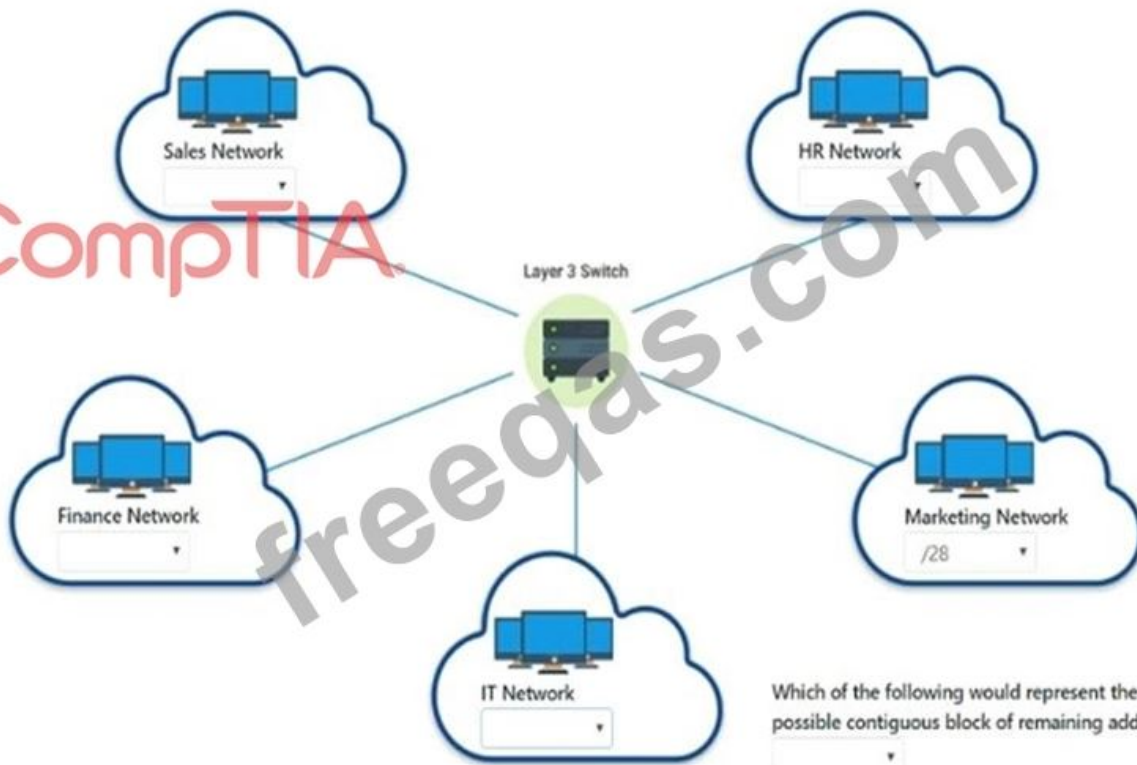

Which of the following would represent the LARGEST possible contiguous block of remaining addresses?

CompTIA

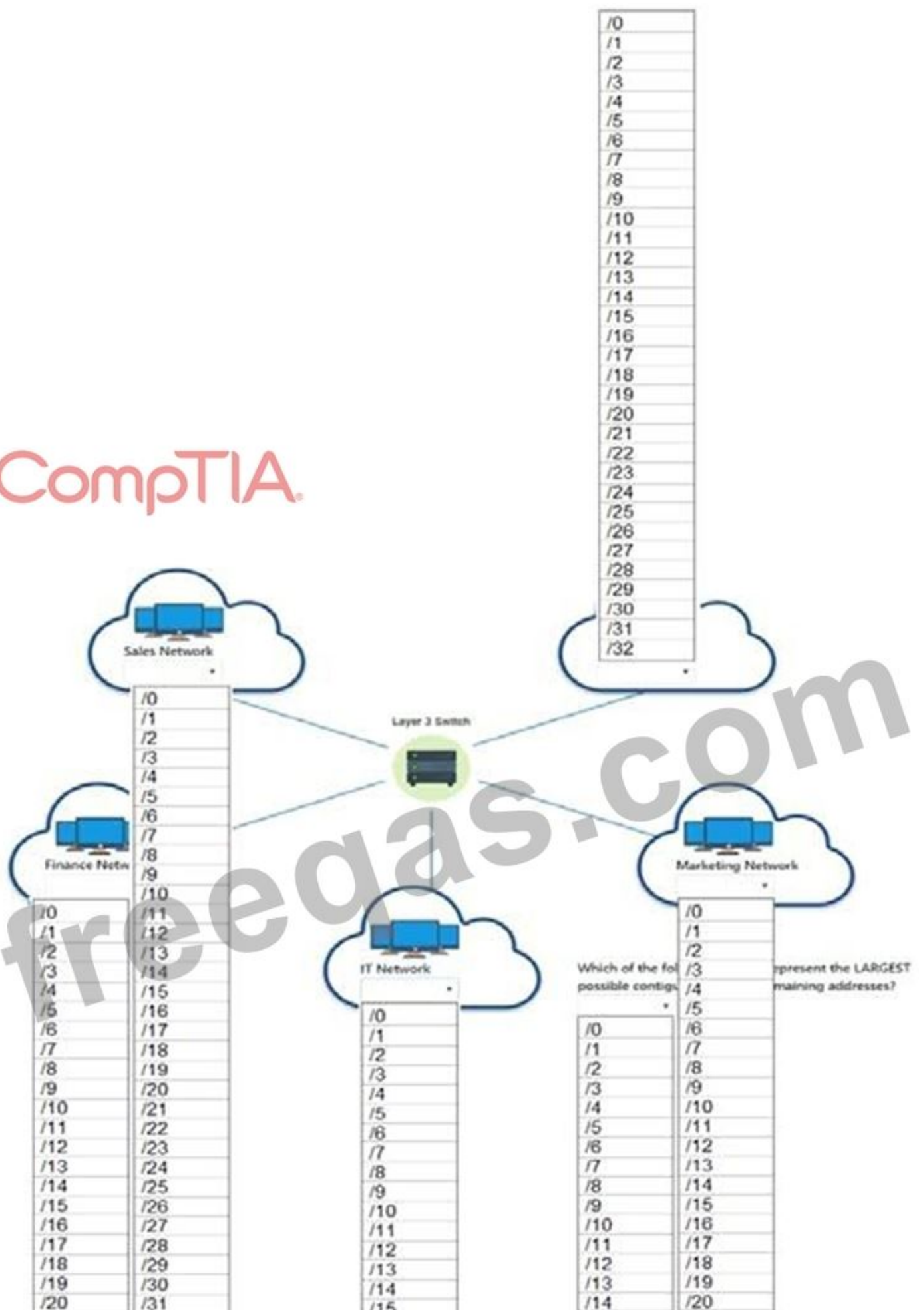

Which of the following possible configurations represent the LARGEST remaining addresses?

- /0
- /1
- /2
- /3
- /4
- /5
- /6
- /7
- /8
- /9
- /10
- /11
- /12
- /13
- /14
- /15
- /16
- /17
- /18
- /19
- /20

/21	/32
/22	
/23	
/24	
/25	
/26	
/27	
/28	
/29	
/30	
/31	
/32	

/15
/16
/17
/18
/19
/20
/21
/22
/23
/24
/25
/26
/27
/28
/29
/30
/31
/32

/15	/21
/16	/22
/17	/23
/18	/24
/19	/25
/20	/26
/21	/27
/22	/28
/23	/29
/24	/30
/25	/31
/26	/32
/27	
/28	
/29	
/30	
/31	
/32	

Answer:

/0
/1
/2
/3
/4
/5
/6
/7
/8
/9
/10
/11
/12
/13
/14
/15
/16
/17
/18
/19
/20
/21
/22
/23
/24
/25
/26
/27
/28
/29
/30
/31
/32

CompTIA

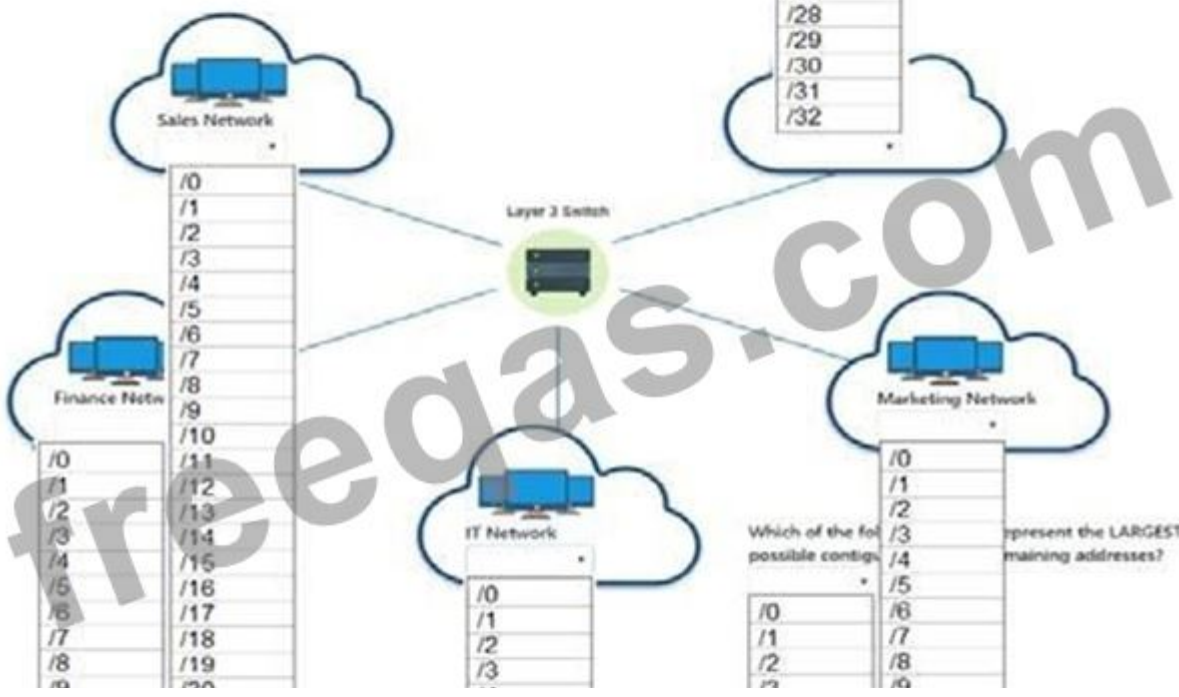

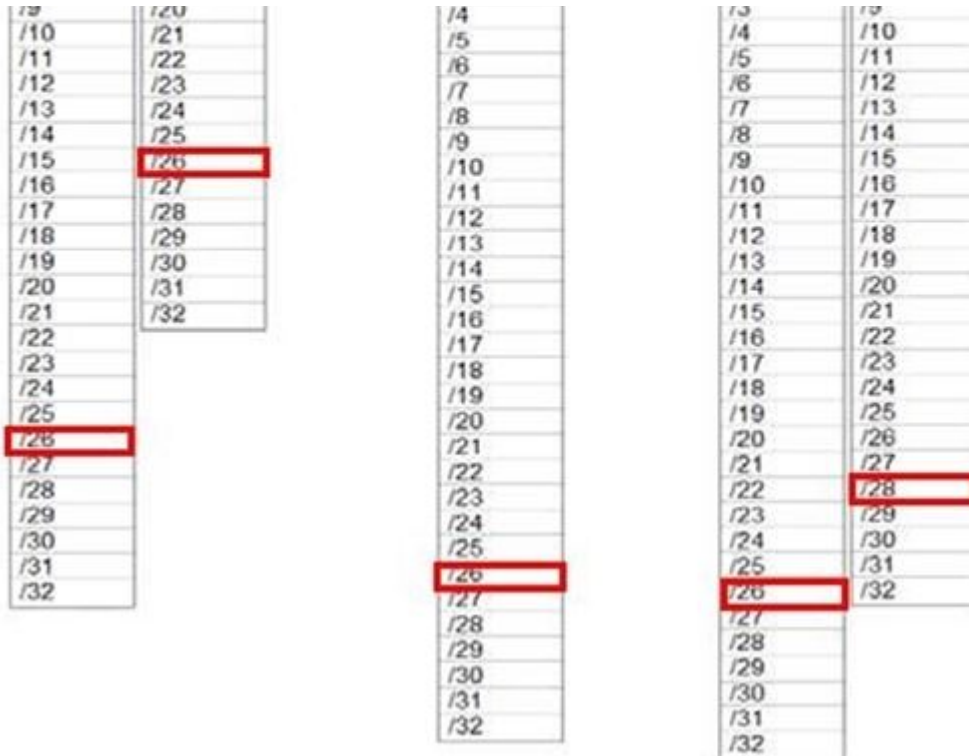

Explanation:

Sales network - /26 - This will provide up to 62 usable IP addresses (64-2 for subnet and broadcast IP)
 HR network - /27 - This will provide for up to 30 usable IP's (32-2)
 IT - /28 - This will provide for up to 14 usable IP's (16-2)
 Finance - /26 - Note that a /27 is 32 IP addresses but 2 of those are reserved for the network and broadcast IP's and can't be used for hosts.
 Marketing - /28

If we add up how many IP blocks are used that is $64+32+16+64+16=192$.

A /24 contains 256 IP addresses, so $256-192=64$.

So the last unused box should be a /26, which equates to 64 addresses

Valid N10-007 Dumps shared by PrepPdf.com for Helping Passing N10-007 Exam!
 PrepPdf.com now offer the **newest N10-007 exam dumps**, the PrepPdf.com N10-007 exam **questions have been updated** and **answers have been corrected** get the **newest** PrepPdf.com N10-007 dumps with Test Engine here:
<https://www.preppdf.com/CompTIA/N10-007-prepaway-exam-dumps.html> (690 Q&As Dumps, **40%OFF Special Discount: Exam-Tests**)

NEW QUESTION: 32

A technician is connecting a PC to a switchport. At the wiring closet, the technician is unable to identify which cable goes from patch panel A connected to the switch to patch panel B connected to the PC. Which of the following tools should the technician use to resolve the issue?

- A. Tone generator
- B. OTDR

C. Cable tester

D. Multimeter

Answer: A ([LEAVE A REPLY](#))

NEW QUESTION: 33

A user reports difficulties connecting a PC to a wired network. The PC connects to an IP phone, which is

working correctly. A network technician can verify that other devices successfully connect to the phone. At

which of the following layers of the OSI model is the problem MOST likely located?

A. Physical

B. Application

C. Transport

D. Network

Answer: D ([LEAVE A REPLY](#))

NEW QUESTION: 34

A user believes a work email account has been compromised. A technician discovers that an email seeming to be from the user's bank shares the same origin IP address as the last login to the email account. Which of the following types of attack is described in this scenario?

A. Ransomware

B. Spam

C. Phishing

D. Man-in-the-middle

Answer: D ([LEAVE A REPLY](#))

NEW QUESTION: 35

A network technician needs to install a new access switch. After installing the new switch, the technician begins to move connections from the old switch to the new switch. The old switch used a GBIC connectors, and the new switch uses an SEF LC with LC connectors. After connecting the SC connector to the SC-to-LC adapter and plugging it to the switch, the link does not come up as expected. Which of the following should a network technician perform NEXT?

A. Replace multimode with single-mode cable

B. Transpose the fiber pairs.

C. Replace SEP with a new one.

D. Fall back to the switch.

Answer: B ([LEAVE A REPLY](#))

NEW QUESTION: 36

A technician must determine if a web page user's visits are connecting to a suspicious website's IP address in the background. Which of the following tools would provide the information on TCP connections?

- A. tracert
- B. route
- C. arp
- D. ipconfig
- E. netstat

Answer: ([SHOW ANSWER](#))

NEW QUESTION: 37

Which of the following IP addresses would be classified as private?

- A. 172.168.5.0
- B. 169.253.10.20
- C. 10.100.200.0
- D. 200.100.25.0

Answer: C ([LEAVE A REPLY](#))

NEW QUESTION: 38

A network technician recently replaced a managed switch in an enterprise network with a new managed switch. Users on the switch can communicate with each other but now cannot access other network segments. Which of the following is the MOST likely reason that the users are unable to access any network segments?

- A. The technician forgot to change the VTP mode on the new switch to server.
- B. The newly installed switch is defective and must be returned.
- C. The technician did not use the correct cable when trunking the new switch.
- D. The newly installed switch is using a different MAC address than the previous switch.

Answer: C ([LEAVE A REPLY](#))

NEW QUESTION: 39

A network technician is connecting two switches together. Which of the following protocols should the technician use to increase speed and fault tolerance?

- A. SIP
- B. LACP
- C. BGP
- D. LLDP

Answer: ([SHOW ANSWER](#))

NEW QUESTION: 40

A user would like to connect two laptops together and transfer files via the Ethernet ports. Which of the following should MOST likely be provided to the user to accomplish this?

- A. Straight cable
- B. Loopback
- C. Crossover
- D. Rollover

Answer: ([SHOW ANSWER](#))

NEW QUESTION: 41

A network technician receives a spool of Cat 6a cable and is asked to build several cables for a new set of Ethernet runs between devices. Which of the following tools are MOST likely needed to complete the task?

(Choose three.)

- A. Wire stripper
- B. Tone generator
- C. Punchdown tool
- D. RJ-45 connectors
- E. RJ-11 connectors
- F. Multimeter
- G. Cable crimper

Answer: A,D,G ([LEAVE A REPLY](#))

NEW QUESTION: 42

A network administrator decides to secure their small network by allowing only specific MAC addresses to gain access to the network from specific switches. Which of the following is described by this example?

- A. Hardware firewalls
- B. Stateful inspection
- C. Port security
- D. Packet filtering

Answer: ([SHOW ANSWER](#))

NEW QUESTION: 43

While testing an ACL on the default gateway router to allow only web browsing, ports TCP 80 and TCP 443 were the only ports open. When tested, no websites were accessible via their URLs inside the network. Which of the following configurations should be added to the ACL?

- A. permit tcp any any eq 8080
- B. permit tcp any any eq 20
- C. permit udp any any eq 68
- D. permit udp any any eq 53
- E. permit tcp any any eq 110
- F. permit udp any any eq 25

Answer: D ([LEAVE A REPLY](#))

NEW QUESTION: 44

A technician is setting up a firewall on the network that would show a public IP address out to the Internet and assign private IP addresses to users inside the network. Which of the following

processes should be set up?

- A. MAC filtering
- B. NAT
- C. Port security
- D. ACL

Answer: B ([LEAVE A REPLY](#))

NEW QUESTION: 45

A network technician is configuring user's access to a VPN concentrator and has advised to use a protocol that supports encryption over UDP.

Which of the following protocols has the technician MOST likely configured for client use?

- A. DTLPS
- B. SNMP
- C. DNS
- D. TFTP

Answer: D ([LEAVE A REPLY](#))

NEW QUESTION: 46

A technician is configuring a default route with IPv6. Which of the following is the correct setting for an IPV6 default rout?

- A. :: 1
- B. :: /0
- C. 2001: :0/64
- D. FE80 : :0/64

Answer: ([SHOW ANSWER](#)**)**

Valid N10-007 Dumps shared by PrepPdf.com for Helping Passing N10-007 Exam!
PrepPdf.com now offer the **newest N10-007 exam dumps**, the PrepPdf.com N10-007 exam **questions have been updated** and **answers have been corrected** get the **newest** PrepPdf.com N10-007 dumps with Test Engine here:
<https://www.preppdf.com/CompTIA/N10-007-prepaway-exam-dumps.html> (**690** Q&As Dumps, **40%OFF** Special Discount: **Exam-Tests**)

NEW QUESTION: 47

A technician needs to set up uplink ports for multiple switches to communicate with one another. ALL VLANs should be transferred from the designed server switch. Which of the following should be set on the uplink ports if VLAN 1 is not the management VLAN? (Select two.)

- A. VTP
- B. 802.1x

- C. STP
- D. Port mirroring
- E. Link aggregation
- F. 802.1q
- G. Port security

Answer: A,C ([LEAVE A REPLY](#))

NEW QUESTION: 48

A company has decided to allow certain users to work remotely by opening up a VPN connection through the firewall. The security policy has been updated to allow VPN connections only from certain users and to specific areas on the network. Along with configuring the correct policies on the firewall, which of the following also needs to be configured on users' mobile devices to allow these VPN connections?

- A. Geotagging application
- B. Credentials
- C. VNC application
- D. Kerberos

Answer: B ([LEAVE A REPLY](#))

NEW QUESTION: 49

A recently constructed building makes use of glass and natural light. Users in the building are reporting poor cellular connectivity and speeds. Which of the following is MOST likely the cause?

- A. Absorption
- B. Channel overlap
- C. Reflection
- D. Frequency mismatch

Answer: C ([LEAVE A REPLY](#))

Explanation/Reference:

NEW QUESTION: 50

A network technician has created a network that consists of a router, a firewall, a switch, and several PCs.

Which of the following physical network topologies was created?

- A. Star
- B. Mesh
- C. Ring
- D. Bus

Answer: D ([LEAVE A REPLY](#))

Section: (none)

NEW QUESTION: 51

Which of the following communication media can carry many voice, data, and video channels simultaneously over multiple frequencies?

- A. Analog modem
- B. CSMA
- C. Broadband
- D. Baseband

Answer: C ([LEAVE A REPLY](#))

NEW QUESTION: 52

Kurt, a network technician, has configured a new firewall on the network. Users are reporting errors when attempting to access several websites. Kurt attempts to access several popular websites with no errors, however, he does receive an error when attempting to access a bank website. Which of the following rules would BEST allow access to the bank website?

- A. Allow UDP port 53
- B. Allow TCP port 80
- C. Allow TCP port 443
- D. Allow UDP port 340

Answer: C ([LEAVE A REPLY](#))

NEW QUESTION: 53

A computer lab on a campus network was recently reconfigured using recycled network cables. One of the 24 computers in the lab is unable to connect to the network after the upgrade. A network technician successfully uses the cable in question to connect directly to another computer. Which of the following is MOST likely issue with the cable?

- A. The cable is rollover cable
- B. The cable is a Cat 5 cable
- C. The cable has bent pins
- D. The cable is a crossover cable

Answer: ([SHOW ANSWER](#))

NEW QUESTION: 54

A small office home office (SOHO) customer is going to be replacing their switch. The customer also wants to add a WAP in a dropped ceiling; however, there are no power outlets above the drop ceiling, but there is a CAT5e network jack. Which of the following technologies should the new switch have to allow this WAP to be placed where the customer requests, without any other major changes to the environment?

- A. VLAN
- B. PoE

C. STP

D. Layer 3 switching

Answer: ([SHOW ANSWER](#))

NEW QUESTION: 55

A SOHO office recently installed a wireless network for employees to use during lunch breaks. As such, the access point was placed in the kitchen area by the microwave.

Employees have been reporting intermittent connectivity when using the wireless network.

Which of the following would BEST improve connectivity?

A. Increase the signal strength

B. Change the broadcast channel

C. Move the access point

D. Disable SSID broadcast

Answer: C ([LEAVE A REPLY](#))

NEW QUESTION: 56

Corporate headquarters provided your office a portion of their class B subnet to use at a new office location.

Range Given: 172.30.232.0/24

* Sales 57 devices

* HR 23 devices

* IT 12 devices

* Finance 32 devices

* Marketing 9 devices

INSTRUCTIONS

Allocate the minimum number of addresses (using CIDR notation) needed to accommodate each department.

After accommodating each department, identify the unused portion of the subnet by responding to the question on the graphic.

All drop downs must be filled.

If at any time you would like to bring back the initial state of the simulation, please click the Reset

All button.

Network Subnet Diagram



Which of the following would represent the LARGEST possible contiguous block of remaining addresses?

CompTIA

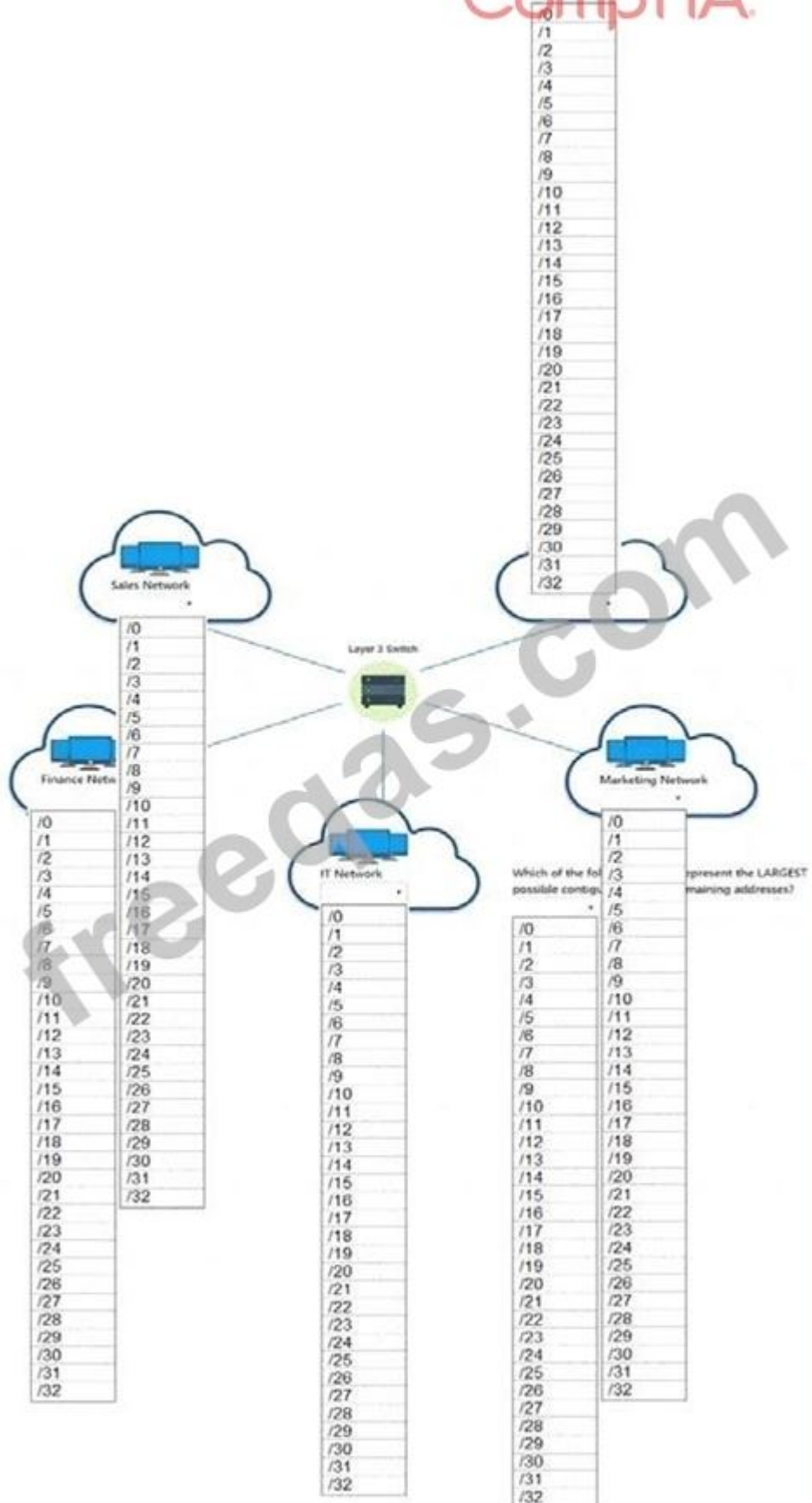

Answer:

/0
/1
/2

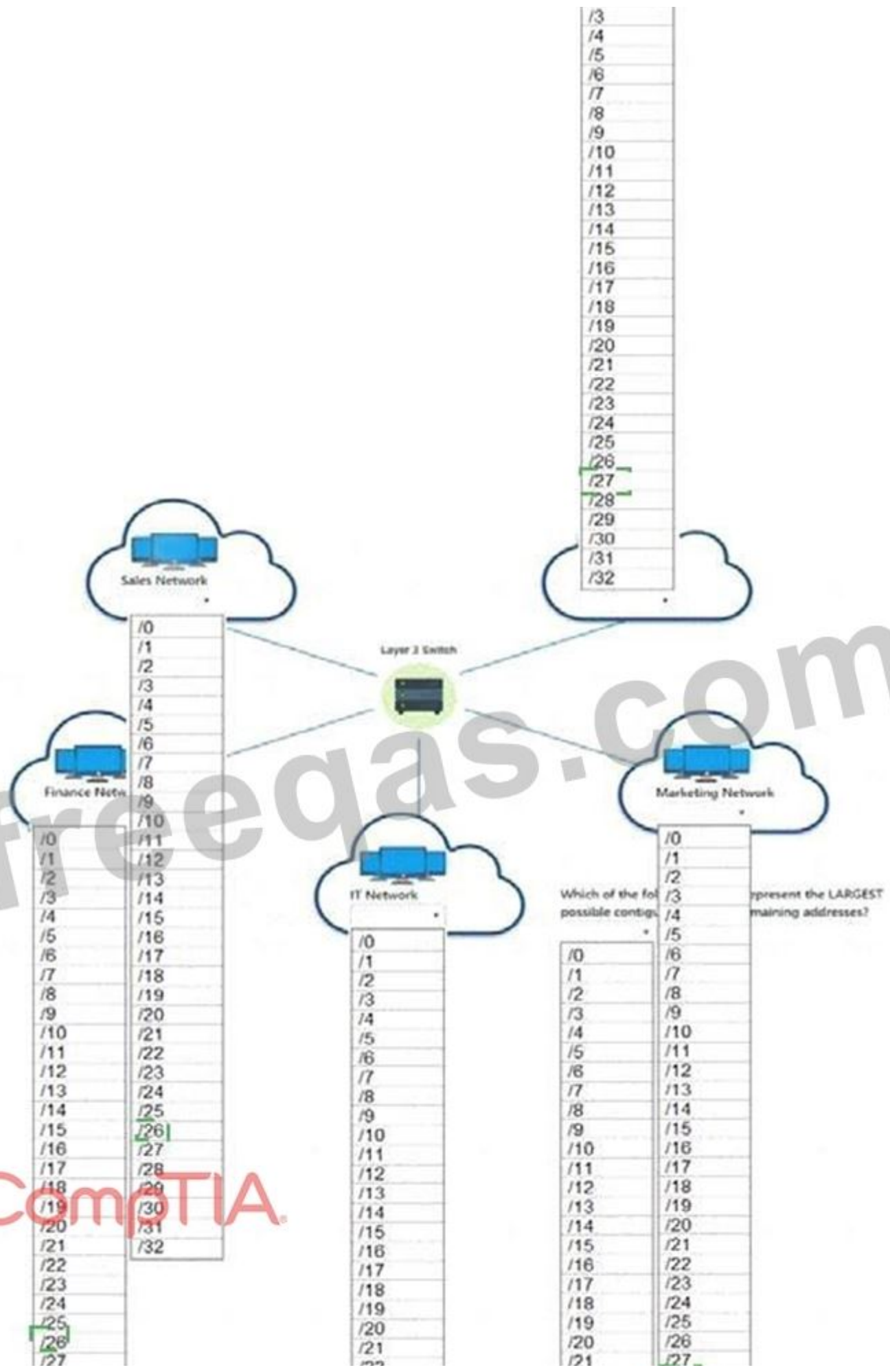

- /3
- /4
- /5
- /6
- /7
- /8
- /9
- /10
- /11
- /12
- /13
- /14
- /15
- /16
- /17
- /18
- /19
- /20
- /21
- /22
- /23
- /24
- /25
- /26
- /27
- /28
- /29
- /30
- /31
- /32



Layer 3 Switch

- /0
- /1
- /2
- /3
- /4
- /5
- /6
- /7
- /8
- /9
- /10
- /11
- /12
- /13
- /14
- /15
- /16
- /17
- /18
- /19
- /20
- /21
- /22
- /23
- /24
- /25
- /26
- /27
- /28
- /29
- /30
- /31
- /32

- /0
- /1
- /2
- /3
- /4
- /5
- /6
- /7
- /8
- /9
- /10
- /11
- /12
- /13
- /14
- /15
- /16
- /17
- /18
- /19
- /20
- /21
- /22
- /23
- /24
- /25
- /26
- /27
- /28
- /29
- /30
- /31
- /32

Which of the following represent the LARGEST remaining addresses?

- /0
- /1
- /2
- /3
- /4
- /5
- /6
- /7
- /8
- /9
- /10
- /11
- /12
- /13
- /14
- /15
- /16
- /17
- /18
- /19
- /20
- /21
- /22
- /23
- /24
- /25
- /26
- /27

CompTIA

/28
/29
/30
/31
/32

/22
/23
/24
/25
/26
/27
/28
/29
/30
/31
/32

/22
/23
/24
/25
/26
/27
/28
/29
/30
/31
/32

Explanation

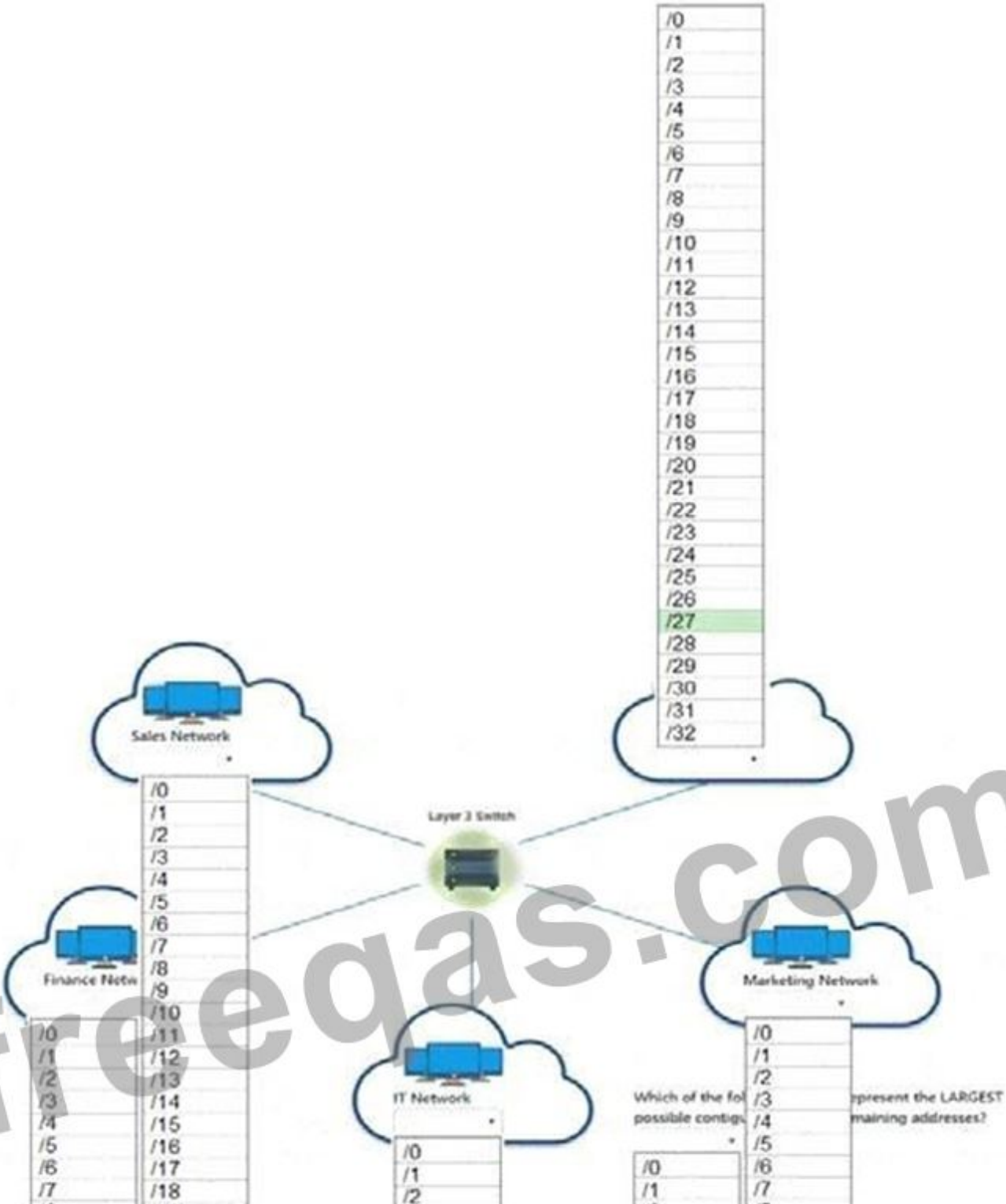

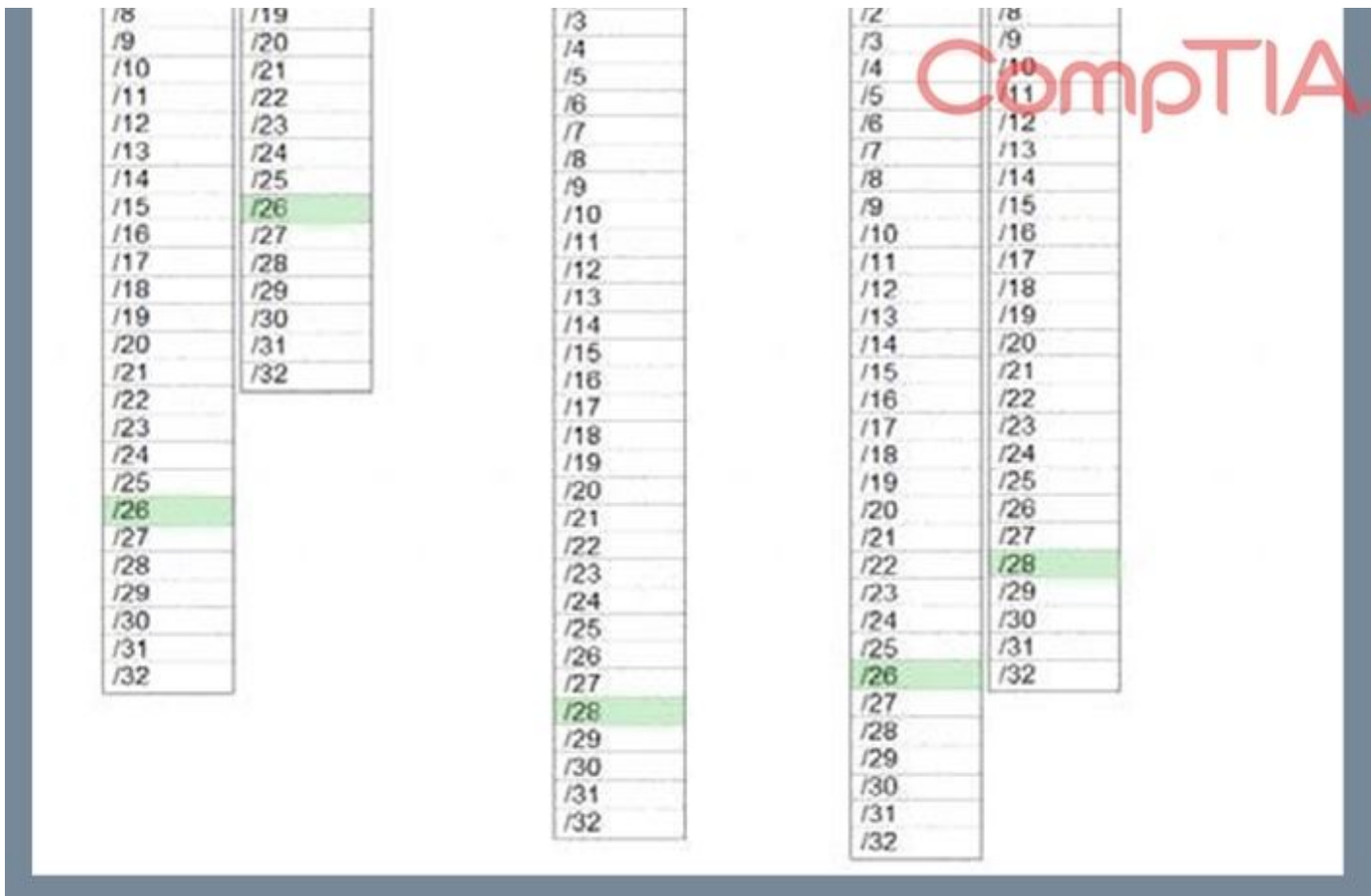

Sales network - /26 - This will provide up to 62 usable IP addresses (64-2 for subnet and broadcast IP) HR network - /27 - This will provide for up to 30 usable IP's (32-2) IT - /28 - This will provide for up to 14 usable IP's (16-2) Finance - /26 - Note that a /27 is 32 IP addresses but 2 of those are reserved for the network and broadcast IP's and can't be used for hosts.

Marketing - /28

If we add up how many IP blocks are used that is $64+32+16+64+16=192$.

A /24 contains 256 IP addresses, so $256-192=64$.

So the last unused box should be a /26, which equates to 64 addresses

NEW QUESTION: 57

A company wants to implement a wireless infrastructure on its campus to meet the needs of its BYOD initiative.

The company has users with legacy devices and wants to accommodate them while delivering speed to other users who have modern systems.

Which of the following standards BEST fits these requirements?

- A. 802.11a
- B. 802.11n
- C. 802.11ac
- D. 802.11b

Answer: B ([LEAVE A REPLY](#))

NEW QUESTION: 58

A network administrator reviews the following command output while troubleshooting a system that is unable to connect to the www.comptia.com website:

```
MacOS:~ user$ ifconfig
eth0: FLAGS=8863<UP,BROADCAST,SMART,RUNNING,PROMISC,SIMPLEX,MULTICAST> mtu 1500
options=60<TS04,TS06>
ether ad:fa:b1:03:77:45
media autoselect <full-duplex>
status: inactive

MacOS:~ user$ dig www.comptia.org
;; global options: +cmd
;; connection timed out; no servers could be reached
```

Which of the following is the reason the system cannot connect?

- A. A cable is not connected to the NIC.
- B. The DNS server is under maintenance.
- C. The interface eth0 is using an APIPA address.
- D. The domain [comptia.com](http://www.comptia.com) is having network issues.

Answer: D ([LEAVE A REPLY](#))

NEW QUESTION: 59

A technician needs to back up network devices to a central location to prepare for a natural disaster. Which of the following should the technician use?

- A. TFTP
- B. VPN
- C. RDP
- D. VNC

Answer: ([SHOW ANSWER](#)**)**

NEW QUESTION: 60

An office user cannot access local network drives but has full access to the Internet. A technician troubleshoots the issue and observes the following output of the `ipconfig` command:

```
Windows IP Configuration

Ethernet LAN Adapter: 980GTS
Connection-specific DNS Suffix: ...comptia.net
IPv4 Address: .....10.0.5.99
Subnet Mask: .....255.255.255.0
Default Gateway: ...10.0.5.1

Wireless LAN Adapter: FastWifi 99
Connection-specific DNS Suffix: ...guestwireless.local
IPv4 Address: .....172.16.0.5
Subnet Mask: .....255.255.255.0
Default Gateway: ...172.16.0.254
```

Which of the following would MOST likely allow the network drives to be accessed?

- A. Disable the LAN adapter
- B. Check the wireless DHCP configuration
- C. Update the WLAN adapter driver
- D. Disable the WLAN adapter

Answer: D ([LEAVE A REPLY](#))

NEW QUESTION: 61

A network technician notices a router that repeatedly reboots. When contacting technical support, the technician discovers this is a known problem in which an attacker can craft packets and send them to the router through an obsolete protocol port, causing the router to reboot. Which of the following did the network technician fail to do? (Choose two.)

- A. Generate new crypto keys.
- B. Keep patches updated.
- C. Disable unnecessary services.
- D. Shut down unused interfaces.
- E. Avoid using common passwords.
- F. Implement file hashing.

Answer: ([SHOW ANSWER](#))

Explanation

Valid N10-007 Dumps shared by PrepPdf.com for Helping Passing N10-007 Exam!
PrepPdf.com now offer the **newest N10-007 exam dumps**, the PrepPdf.com N10-007 exam **questions have been updated** and **answers have been corrected** get the **newest** PrepPdf.com N10-007 dumps with Test Engine here:
<https://www.preppdf.com/CompTIA/N10-007-prepaway-exam-dumps.html> (**690** Q&As Dumps, **40%OFF Special Discount: Exam-Tests**)

NEW QUESTION: 62

A technician is allocating the IP address space needed for a new remote office. This office will contain the engineering staff with six employees and the digital marketing staff with 55 employees. The technician has decided to allocate the 192.168.1.0/24 block to the remote office. The engineering staff has been allocated the 192.168.1.64/29 subnet. Using the LEAST amount of space possible, which of the following would be the last usable IP address in the engineering subnet?

- A. 192.168.1.71
- B. 192.168.1.63
- C. 192.168.1.62
- D. 192.168.1.70

Answer: C ([LEAVE A REPLY](#))

NEW QUESTION: 63

A technician is configuring a printer for a client. The which of the following types to the network, But is unsure how to determine its switch port. Which of the following should the technician do FIRST to locate switch port?

- A. Set up a SSH session to the desktop
- B. perform a DNS lookup on the server.
- C. Reference the ARP table in the router
- D. Configure port security on the switch.

Answer: D ([LEAVE A REPLY](#))

NEW QUESTION: 64

The systems administrator has assigned an IP address and default gateway to a standard Layer 2 switch. Which of the following would be the primary purpose of doing this?

- A. Allow VLAN routing
- B. Enable packet filtering on the switch
- C. Enable MAC filtering on the switch
- D. Allow remote administration of the switch

Answer: D ([LEAVE A REPLY](#))

NEW QUESTION: 65

A network technician is installing a new network switch in the MDF. The technician is using fiber to connect the switch back to the core. Which of the following transceiver types should the technician use?

- A. GBIC
- B. F-type
- C. BNC
- D. MT-RJ

Answer: A ([LEAVE A REPLY](#))

NEW QUESTION: 66

Workstations are unable to access the Internet after a recent power outage. Configure the appropriate devices to ensure ALL workstations have Internet connectivity.

Instructions: All ports can be enabled (green) or disabled (red). When you have completed the simulation please select the Done button.

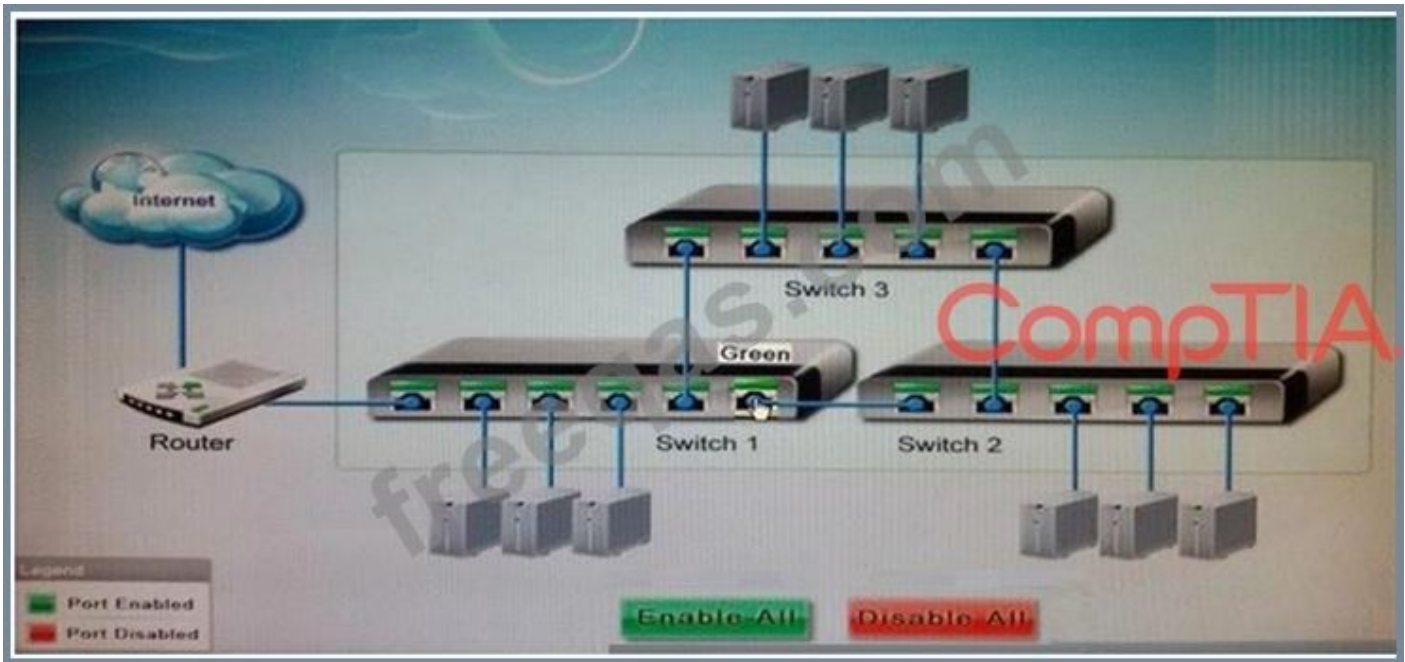

Answer:

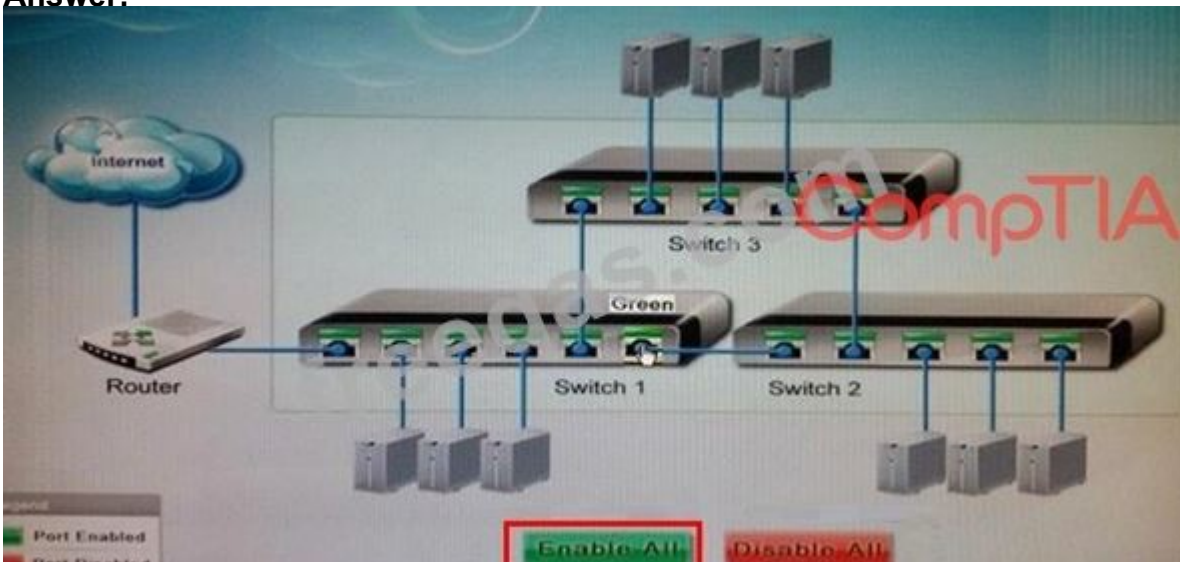

NEW QUESTION: 67

A technician is moving a company to a cloud email service. Several external recipients are reporting that email sent from the company is going to their junk folders because the sender's identity cannot be verified. Which of the following DNS record types should the technician modify to minimize this problem?

- A. SRV
- B. PTR
- C. TXT
- D. CNAME

Answer: B ([LEAVE A REPLY](#))

NEW QUESTION: 68

Which of the following should a network administrator deploy to control all preventive security measures?

- A. Proxy
- B. IDS
- C. UTM
- D. Firewall

Answer: C ([LEAVE A REPLY](#))

NEW QUESTION: 69

A company's sales department is accustomed to sharing information with other organizations via FTP; however, FTP recently stopped working for the sales employees. Upon further review, it is determined a junior network technician recently applied an ACL without going through the proper change management process. The network administrator found the following ACL:

```
ip access-list extended "TEST-ACL-SALES-01"
 10 remark "ALLOW USER ACCESS TO DHCP ETC"
 20 permit udp 0.0.0.0 255.255.255.255 host 10.2.1.2 eq 53
 30 permit udp 0.0.0.0 255.255.255.255 host 10.2.1.2 range 67 69
 40 remark "ALLOW USER ACCESS TO LDAP"
 50 permit tcp 0.0.0.0 255.255.255.255 host 10.2.4.28 eq 389
 60 permit tcp 0.0.0.0 255.255.255.255 host 10.2.4.28 eq 636
 70 remark "ALLOW USER ACCESS TO HTTP/S"
 80 permit tcp 0.0.0.0 255.255.255.255 0.0.0.0 255.255.255.255 eq 80
 90 deny tcp 0.0.0.0 255.255.255.255 0.0.0.0 255.255.255.255 eq 443
100 remark "ALLOW USER ACCESS TO FTP"
110 allow top 0.0.0.0 255.255.255.255 0.0.0.0 255.255.255.255 eq 22
120 remark "DENY ALL OTHER TRAFFIC"
130 deny ip 0.0.0.0 255.255.255.255 0.0.0.0 255.255.255.255
```

Which of the following statement Identifies the main Issue?

- A. An extended ACL is being used rather man a standard ACL.
- B. DNS needs to De allowed before FIP will work.
- C. The ACL contains an Incorrect port number.
- D. The ACL was applied incorrectly to the interface.

Answer: A ([LEAVE A REPLY](#))

NEW QUESTION: 70

A technician is connecting a router directly to a PC using the G1/0/1 interface. Without the use of auto- sensing ports, which of the following cables should be used?

- A. Console
- B. Crossover
- C. Rollover
- D. Straight-through

Answer: B ([LEAVE A REPLY](#))

NEW QUESTION: 71

A new monitoring device is installed in the network that uses ping to determine whether critical network Internet routers are up. After three missing pings, the alarm reports the device is down. The device is now constantly reporting alarms, yet there are no reported Internet problems from users. Which of the following is the MOST likely cause?

- A. Incorrect VLAN assignment on the router.
- B. A missing route on the alarm device.
- C. Incorrect speed/duplex setting on the alarm device.

D. A missing route on the network routers.

Answer: C ([LEAVE A REPLY](#))

NEW QUESTION: 72

Kim, a technician, needs to locate a cable in an unorganized wiring closet.

Which of the following tools will help her locate the cable?

A. Cable tester

B. Toner probe

C. Punch down tool

D. Protocol analyzer

Answer: B ([LEAVE A REPLY](#))

NEW QUESTION: 73

Employees at a company report that they are unable to access the Internet. A network technician notices the workstations are receiving IP addresses that do not follow the IP addressing scheme of the corporate network.

Upon further inspection, the technician finds an employee has plugged a rogue wireless router into the corporate network. Which of the following settings would have prevented this situation?

A. DHCP snooping

B. DHCP leasing

C. DHCP relay

D. DHCP options

Answer: A ([LEAVE A REPLY](#))

NEW QUESTION: 74

A Chief Information Security Officer (CISO) has decided to implement a secure and user-friendly way to connect to the corporate wireless network. Each workstation will be authenticated individually using a unique certificate that will be deployed to the workstation by the organization's certificate authority. Which of the following authentication methods would meet this requirement?

A. WPA2-PSK

B. Captive portal

C. EAP-TLS

D. PEAP

Answer: C ([LEAVE A REPLY](#))

NEW QUESTION: 75

Which of the following BEST explains why a firewall would be subject to international export controls?

A. Encryption technology

B. Protected industry

C. IP version incompatibility

D. Differing power standards

Answer: ([SHOW ANSWER](#))

NEW QUESTION: 76

A network technician does not have access to the GUI of a server and needs to adjust some network properties. Given the command:

```
route add 0.0.0.0 mask 0.0.0.0 192.169.1.222 metric 1
```

Which of the following is the technician attempting to alter?

- A. The technician is clearing the route table.
- B. The technician is adding a static IP address.
- C. The technician is clearing the subnet mask setting.**
- D. The technician is setting the default gateway.

Answer: C ([LEAVE A REPLY](#))

Valid N10-007 Dumps shared by PrepPdf.com for Helping Passing N10-007 Exam!
PrepPdf.com now offer the **newest N10-007 exam dumps**, the PrepPdf.com N10-007 exam **questions have been updated** and **answers have been corrected** get the **newest** PrepPdf.com N10-007 dumps with Test Engine here:
<https://www.preppdf.com/CompTIA/N10-007-prepaway-exam-dumps.html> (**690** Q&As Dumps, **40%OFF** Special Discount: **Exam-Tests**)

NEW QUESTION: 77

A small team is overloaded with requests for database resources. The Chief Information Officer (CIO) is concerned the company does not have the resources to deploy and manage these additional services efficiently. Which of the following types of cloud services would be the MOST effective?

- A. SaaS
- B. PaaS
- C. BaaS
- D. IaaS

Answer: C ([LEAVE A REPLY](#))

NEW QUESTION: 78

A network administrator frequently needs to assist users with troubleshooting network hardware remotely, but the users are non-technical and unfamiliar with network devices. Which of the following would BEST help the administrator and users during hands-on troubleshooting?

- A. Standard operating procedures
- B. Logical diagrams
- C. MDF documentation
- D. Equipment labeling

Answer: A ([LEAVE A REPLY](#))

NEW QUESTION: 79

Which of the following DNS record types can help limit spam?

- A. SRV
- B. MX
- C. A
- D. SPF

Answer: D ([LEAVE A REPLY](#))

NEW QUESTION: 80

The backups server connects to a NAS device using block-level storage over Ethernet. The performance is very slow, however, and the network technician suspects the performance issues are network related. Which of the following should the technician do to improve performance?

- A. Utilize UDP to eliminate packet overhead
- B. Turn off MDIX settings on the NAS and server switchports
- C. Enable jumbo frames on the NAS and server
- D. Encapsulate the storage traffic in a GRE tunnel

Answer: C ([LEAVE A REPLY](#))

NEW QUESTION: 81

A network technician is responsible for the basic security of the network. Management has asked if there is a way to improve the level of access users have to the company file server. Right now, any employee can upload and download files with basic system credentials. Which of the following would require additional credentials?

- A. MDS authentication
- B. Kerberos authentication
- C. Single sign-on authentication
- D. Multifactor authentication

Answer: D ([LEAVE A REPLY](#))

NEW QUESTION: 82

Which of the following properties should be configured to extend logical network separation on an uplink interface to a second switch?

- A. Multiple untagged ports
- B. 802.1Q trunking
- C. Port mirroring
- D. Management VLAN

Answer: ([SHOW ANSWER](#))

NEW QUESTION: 83

A critical vulnerable is discovered on a network device. The vendor state it has already patched

this vulnerable in its current release. Which of the following actions should an administrator take?

- A. Change the default password.
- B. Use a firewall in front of the device.
- C. Upgrade the configuration.
- D. Update the firmware.

Answer: ([SHOW ANSWER](#))

NEW QUESTION: 84

Which of the following policies prohibits a network administrator from using spare servers in the datacenter to mine bitcoins?

- A. AUP
- B. MOU
- C. BYOD
- D. NDA

Answer: A ([LEAVE A REPLY](#))

NEW QUESTION: 85

A wireless client is having issues staying connected to the wireless network even though the client is less than

20ft (6m) from the access point. Which of the following is MOST likely the cause?

- A. Absorption
- B. Security type mismatch
- C. Latency
- D. Distance limitations

Answer: A ([LEAVE A REPLY](#))

NEW QUESTION: 86

Which of the following devices should a network administrator configure on the outermost part of the network?

- A. Media converter
- B. Modem
- C. Switch
- D. Firewall

Answer: D ([LEAVE A REPLY](#))

NEW QUESTION: 87

Something you have, something you are, and something you know are the three tenets of:

- A. Remote access
- B. Change management
- C. Access control
- D. Social engineering

Answer: C ([LEAVE A REPLY](#))

NEW QUESTION: 88

A technician needs a way to allow clients to access a new application server on the network. Which of the following should the technician set up to achieve this objective? (Select TWO)

- A. DNS SRV record
- B. DHCP MAC reservation
- C. DHCP IP reservation
- D. DHCP scope option
- E. DNS reverse zone
- F. Cloud-hosted DNS

Answer: ([SHOW ANSWER](#))

NEW QUESTION: 89

Which of the following ports should a network technician open on a firewall to back up the configuration and operating system files of a router to a remote server using the FASTEST method possible?

- A. TCP port 25
- B. UDP port 22
- C. TCP port 22
- D. UDP port 69
- E. UDP port 53

Answer: D ([LEAVE A REPLY](#))

NEW QUESTION: 90

A technician is configuring a new email server and needs to modify DNS records. Which of the following records should the technician update to ensure email functions as expected?

- A. CNAME
- B. SRV
- C. AAAA
- D. MX

Answer: A ([LEAVE A REPLY](#))

NEW QUESTION: 91

An attacker has inserted a hub into a trunk link on the local network in an attempt to access the management subnet to attack the networking devices. Which of the following attacks can be used on a trunk link to provide access to the management subnet?

- A. Brute force
- B. DNS poisoning
- C. VLAN hopping
- D. Evil twin

Answer: ([SHOW ANSWER](#))

Valid N10-007 Dumps shared by PrepPdf.com for Helping Passing N10-007 Exam!
PrepPdf.com now offer the **newest N10-007 exam dumps**, the PrepPdf.com N10-007 exam **questions have been updated** and **answers have been corrected** get the **newest** PrepPdf.com N10-007 dumps with Test Engine here:
<https://www.preppdf.com/CompTIA/N10-007-prepaway-exam-dumps.html> (**690 Q&As Dumps**, **40%OFF Special Discount: Exam-Tests**)

NEW QUESTION: 92

A network technician notices the site-to-site VPN and Internet connection have not come back up at a branch office after a recent power outage. Which of the following is an out-of-band method the technician would MOST likely utilize to check the branch office's router status?

- A. Walk a user through troubleshooting the connection
- B. Use a modem to console into the router
- C. Travel to the branch office
- D. Hire a contractor to go on-site

Answer: B ([LEAVE A REPLY](#))

NEW QUESTION: 93

A network technician is configuring user access to a VPN concentrator and has been advised to use a protocol that supports encryption over UDP. Which of the following protocols has the technician MOST likely configured for client use?

- A. DTLS
- B. SNMP
- C. TFTP
- D. DNS

Answer: A ([LEAVE A REPLY](#))

NEW QUESTION: 94

Which of the following defines when Pete, an attacker, attempts to monitor wireless traffic in order to perform malicious activities?

- A. SQL injection
- B. Directory traversal
- C. Packet sniffing
- D. XSS

Answer: C ([LEAVE A REPLY](#))

NEW QUESTION: 95

A network administrator is setting up several IoT devices on a new VLAN and wants to accomplish the following

1. Reduce manual configuration on each system
2. Assign a specific IP address to each system
3. Allow devices to move to different switchports on the same VLAN

Which of the following should the network administrator do to accomplish these requirements?

- A. Implement private VLANs for each device
- B. Set up a reservation for each device
- C. Use DHCP exclusions to address each device
- D. Configure a static IP on each device

Answer: A (LEAVE A REPLY)

NEW QUESTION: 96

A technician has deployed an additional DHCP server for redundancy. Clients in certain subnets are not

receiving DHCP leases from the new DHCP server. Which of the following is the MOST likely cause?

- A. The ARP table on the router needs to be cleared.
- B. The new DHCP server is not receiving the requests from the clients.
- C. The ARP cache of the new DHCP server needs to be updated.
- D. The new DHCP server's IP address was not added to the router's IP helper list.

Answer: D (LEAVE A REPLY)

NEW QUESTION: 97

A network administrator is redesigning network security after an attack. During the attack, an attacker used open cubicle locations to attach devices to the network. The administrator wants to be able to monitor future attacks in a safe environment and determine the method of attack.

Which of the following should the administrator do to BEST meet this requirement?

- A. Create a VLAN for the unused ports and create a honeypot on the VLAN.
- B. Install a BPDU guard on switchports and enable STP.
- C. Create a DMZ for public servers and secure a segment for the internal network.
- D. Install antivirus software and set an ACL on the servers.

Answer: A (LEAVE A REPLY)

Explanation/Reference:

NEW QUESTION: 98

A network technician is troubleshooting a connectivity issue with Joe, a user. Joe has reported that when he attempts to RDP to machine1 (192.168.21.21) by name, he is connected to machine3 (192.168.21.23). When the network technician runs the command `nslookup machine1`, it returns the IP address 192.168.21.23; but when the `ping 192.168.21.23` command is run, the

results return the hostname machine3. Which of the following DNS records should be updated to allow RDP connections to machine1 by hostname?

- A. A
- B. TXT
- C. PTR
- D. SRV

Answer: A ([LEAVE A REPLY](#))

NEW QUESTION: 99

A technician needs to connect two routers using copper cables. Which of the following cables would utilize both the TIA/EIA 568a and TIA/EIA 568b standards?

- A. Cat6 console
- B. Cat5e rollover
- C. Cat6a straight-through
- D. Cat5e straight-through
- E. Cat5 crossover

Answer: E ([LEAVE A REPLY](#))

NEW QUESTION: 100

A network technician is creating a new subnet for 488 host machines. The technician is told to use a class B address scheme when making the subnet and is instructed to leave as much room as possible for additional subnets of the same size. Which of the following subnets would fulfill these requirements?

- A. 10.233.2.0/23
- B. 192.168.25.0/24
- C. 172.18.0.0/23
- D. 10.5.4.0/22
- E. 172.16.0.0/22

Answer: ([SHOW ANSWER](#))

NEW QUESTION: 101

The network team at a university, which has on-campus residences, recently expanded the WiFi offerings to the dormitories. Each dormitory houses approximately 75 students, who each have multiple wireless devices. The WLAN utilizes an intelligent wireless controller for configuration and management. While the WiFi in academic buildings continues to receive few to no complaints, dormitory complaints are on the rise. Which of the following is MOST likely causing the complaints?

- A. Frequency mismatch
- B. Channel overlap
- C. Interference
- D. Crosstalk

Answer: A ([LEAVE A REPLY](#))

NEW QUESTION: 102

Allowing data to be centrally stored and accessed by multiple devices on an isolated subnet is BEST understood as:

- A. iSCSI
- B. SAN**
- C. NAS
- D. FCoE

Answer: B ([LEAVE A REPLY](#))

NEW QUESTION: 103

A network engineer needs to connect two network switches with a gigabit link. The proposed route to run the 164ft (50m) cable is directly underneath a large electrical generator. Which of the following cable types would BEST fit the needs of the network engineer?

- A. UTP
- B. Cat 5 plenum**
- C. STP
- D. Coaxial

Answer: B ([LEAVE A REPLY](#))

NEW QUESTION: 104

Joe a user, is having issues when trying to access certain web pages Upon navigating to a web page it seems like it connects, but then presents the following message:

```
The security certificate presented by this website was not trusted by a trusted certificate authority.
```

Joe has cleared his cache and cookies rebooted his machine, and attempted to browse to the website from a coworker's desktop but is still presented with this error Which of the following is the MOST likely cause of this error?

- A. The SSL certificate has expired**
- B. TLS is not enabled in the browser
- C. The website is missing an HTTPS certificate
- D. The web server is missing an intermediate certificate

Answer: A ([LEAVE A REPLY](#))

NEW QUESTION: 105

An employee, who is using a laptop connected to the wireless network. Is able to connect to the Internet but not to internal company resources. A systems administrator reviews the following information from the laptop:

```
IP: 192.168.1.100  
MASK: 255.255.255.0  
ROUTER: 192.168.1.1
```

The administrator was expecting to see a network address within 10.100.0.0/23. which is consistent with the company's wireless network. The network administrator verifies the company's wireless network is configured and working properly. Which of the following is the MOST likely cause of this issue?

- A. Security type mismatch
- B. Interference
- C. Wrong SSID
- D. Channel overlap

Answer: C ([LEAVE A REPLY](#))

NEW QUESTION: 106

A disgruntled employee decides to leak critical information about a company's new product. The employee places keyloggers on the department's computers, allowing the information to be sent out to the Internet. Which of the following attacks is occurring?

- A. Insider threat
- B. Social engineering
- C. Man-in-the-middle
- D. Logic bomb

Answer: ([SHOW ANSWER](#)**)**

Valid N10-007 Dumps shared by PrepPdf.com for Helping Passing N10-007 Exam!
PrepPdf.com now offer the **newest N10-007 exam dumps**, the PrepPdf.com N10-007 exam **questions have been updated** and **answers have been corrected** get the **newest** PrepPdf.com N10-007 dumps with Test Engine here:
<https://www.preppdf.com/CompTIA/N10-007-prepaway-exam-dumps.html> (**690** Q&As Dumps, **40%OFF** Special Discount: **Exam-Tests**)

NEW QUESTION: 107

The corporate head office has assigned the subnet of 10.1.100.0/24 to a network technician. The technician wants to create subnets for the finance department, human resources, and IT. Given the following device counts:

Finance: 70 devices

Human resources: 38 devices

IT: 16 devices

Which of the following outlines how the technician should allocate the address space given?

CompTIA

Finance: 10.1.100.0/21
Human resources: 10.1.100.128/22
IT: 10.1.100.192/23

Finance: 10.1.100.0/23
Human resources: 10.1.100.128/22
IT: 10.1.100.192/21

Finance: 10.1.100.0/25
Human resources: 10.1.100.128/26
IT: 10.1.100.192/27

Finance: 10.1.100.0/26
Human resources: 10.1.100.128/27
IT: 10.1.100.192/28

- A. Option A
- B. Option D
- C. Option C
- D. Option B

Answer: C ([LEAVE A REPLY](#))

NEW QUESTION: 108

A network technician is coordinating the upgrade of the company's WAP firmware with all the remote locations. The company has occasionally experienced errors when transferring large files to some of the remote offices. Which of the following should be used to ensure files arrive without modifications?

- A. Compression
- B. File hash
- C. Encryption
- D. FCS

Answer: B ([LEAVE A REPLY](#))

NEW QUESTION: 109

A user reports network resources can no longer be accessed. The PC reports a link but will only

accept static IP addresses. The technician pings other devices on the subnet, but the PC displays the message Destination unreachable. Which of the following are MOST likely the causes of this issue? (Choose two.)

- A. Crosstalk
- B. Damaged cables
- C. VLAN mismatch
- D. Bent pins
- E. Duplex mismatch
- F. TX/RX reverse

Answer: C,D (LEAVE A REPLY)

NEW QUESTION: 110

A network technician is attempting to troubleshoot a connectivity issue. The issue is only reported during the evening hours, and only a single workstation loses connectivity. Which of the following is the MOST likely cause of the issue?

- A. Nightly backups are consuming excessive bandwidth.
- B. The router has a time-based ACL, applied for the network segment.
- C. A light source is creating EMI interference, affecting the UTP cabling.
- D. The user has violated the AUP, and Internet access has been restricted.

Answer: D (LEAVE A REPLY)

NEW QUESTION: 111

Drag and Drop Question
Build a T-658A Connection



Answer:



NEW QUESTION: 112

Which of the following can be done to implement network device hardening (Select TWO).

- A. Implement spanning tree
- B. Perform VLAN hopping
- C. Patch and update
- D. Perform backups
- E. Enable port mirroring
- F. Change default admin password

Answer: C,F (LEAVE A REPLY)

Network devices come with default credentials, the username and password that enables you to log into the device for configuration. Changing default credentials should be the first step in hardening a new device. As with any other system, avoiding common passwords adds security. Keep network devices up to date. That means upgrading firmware, patching and updating as necessary to close any security gaps exposed over time.

Services on network devices like routers include common things, like Telnet and HTTP access; and also things you don't normally see, like TCP and UDP small services, debugging and testing tools that primarily use ports 20 and lower. If enabled, these services can be used to launch DoS and other attacks. All modern Cisco devices have these disabled; Cisco's hardening rules insist on disabling unnecessary services.

Using secure protocols hardens network devices. Don't use Telnet to access a managed switch or router, for example, but use SSH so that the communication is encrypted.

Disabling unused ports on network devices enhances port security for access control.

This includes standard IP ports and device ports, both physical and virtual for the latter.

NEW QUESTION: 113

Which of the following allow for higher fault tolerance, availability, and performance across multiple systems?

(Choose two.)

- A. Load balancer
- B. Jumbo frames
- C. Clustering
- D. Round robin
- E. TCP offloading

Answer: A,C ([LEAVE A REPLY](#))

Explanation/Reference:

NEW QUESTION: 114

Which of the following allows for connectionless communications?

- A. TGP
- B. MAG
- C. UDP
- D. IF

Answer: A ([LEAVE A REPLY](#))

NEW QUESTION: 115

Which of the following assists a network administrator in reverse engineering malware and viruses?

- A. IDS
- B. Virtual machines
- C. VLANs
- D. Virtual switches

Answer: ([SHOW ANSWER](#))

NEW QUESTION: 116

A network technician is working on a new switch implementation to expand the network. Which of the following is the BEST option to ensure the implementation goes according to business requirements?

- A. AUP
- B. SLA
- C. NDA
- D. SOP

Answer: D ([LEAVE A REPLY](#))

NEW QUESTION: 117

After rebooting a PC, a user is no longer able to connect to the corporate network. As a test, the technician plugs a different laptop into the same network jack and receives an IP address of 169.254.112.137. Which of the following is MOST likely causing the issue?

- A. Port-security violation
- B. Incorrect ACL setting

- C. Improper DNS setting
- D. DHCP scope exhaustion

Answer: D ([LEAVE A REPLY](#))

NEW QUESTION: 118

A store owner would like to have secure wireless access available for both equipment and patron use. Which of the following features should be configured to allow different wireless access through the same equipment?

- A. SSID
- B. LTE
- C. MIMO
- D. TKIP

Answer: A ([LEAVE A REPLY](#))

NEW QUESTION: 119

Which of the following **MUST** be installed on an employee's computer if the remote access VPN implements an SSL VPN with PKI authentication?

- A. Shared secret
- B. HTTPS server
- C. Soft token
- D. Private certificate

Answer: D ([LEAVE A REPLY](#))

NEW QUESTION: 120

Which of the following devices, if implemented, would result in decreased administration time of an 802.11 network running centralized authentication services? (Choose two.)

- A. RADIUS server
- B. Wireless controller
- C. VPN concentrator
- D. Multilayer switch
- E. Proxy server

Answer: ([SHOW ANSWER](#))

NEW QUESTION: 121

A network technician needs a secure way to access a router in another country. Which of the following methods would meet this requirement?

- A. TFTP upload
- B. SSH connection
- C. GRE tunnel
- D. Device HTTP URL

Answer: B ([LEAVE A REPLY](#))

Valid N10-007 Dumps shared by PrepPdf.com for Helping Passing N10-007 Exam!
PrepPdf.com now offer the **newest N10-007 exam dumps**, the PrepPdf.com N10-007 exam **questions have been updated** and **answers have been corrected** get the **newest** PrepPdf.com N10-007 dumps with Test Engine here:
<https://www.preppdf.com/CompTIA/N10-007-prepaway-exam-dumps.html> (690 Q&As Dumps, **40%OFF Special Discount: Exam-Tests**)

NEW QUESTION: 122

Users are reporting issues with slow connection speeds and a loss of connectivity on the newly installed wireless network. The issues are intermittent but seem to occur most often around midday.

Which of the following is the MOST likely cause?

- A. The signal coverage area is too small
- B. There is interference from small appliances
- C. Not enough DHCP addresses have been allotted
- D. The DNS cache on the users' computers has become corrupt

Answer: (SHOW ANSWER)

NEW QUESTION: 123

A user no longer has access to network resources after a recent office move, but all other users in the building are able to connect at 100MB connections. After further investigation, a network technician notices the following information:

Network information for the building:

VLAN 200
Network 10.1.206.0/24
Subnet mask 255.255.255.0

Wire maps results:

1	-	-	-	-	-	-	1
2	-	-	-	-	-	-	2
3	-	-	-	-	-	-	3
4	-	-	-	-	-	-	4
5	-	-	-	-	-	-	5
6	-	-	-	-	-	-	6
7	-	-	-	-	-	-	7
8	-	-	-	-	-	-	8

Cable distance:

225ft (69m)

Switchport configuration results:

```
fastethernet1/3/47  
switchport  
vlan 200  
shutdown
```

Which of the following is causing the network connection issues?

- A. Open/short pins
- B. Distance limitation
- C. VLAN mismatch
- D. Port configuration
- E. Crosstalk

Answer: D ([LEAVE A REPLY](#))

NEW QUESTION: 124

A technician is installing a cable modem in a SOHO. Which of the following cable types will the technician MOST likely use to connect a modem to the ISP?

- A. Single-mode fiber
- B. Cat 6e
- C. Coaxial

D. Multimode fiber

Answer: B ([LEAVE A REPLY](#))

NEW QUESTION: 125

Workstations are unable to access the Internet after a recent power outage. Configure the appropriate devices to ensure ALL workstations have Internet connectivity.

Instructions: All ports can be enabled (green) or disabled (red). When you have completed the simulation please select the Done button.

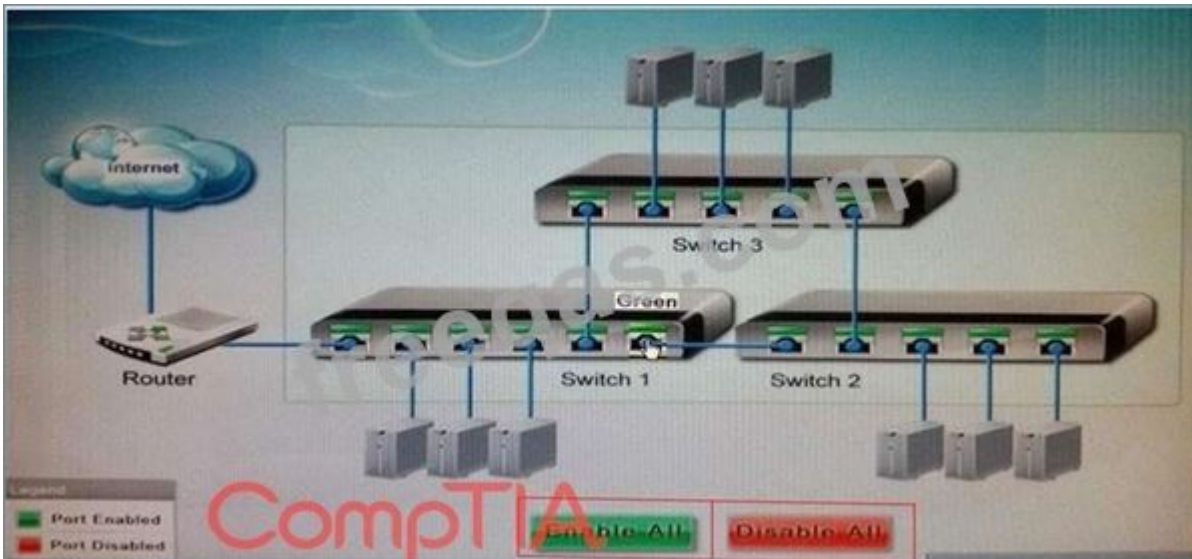

Answer:

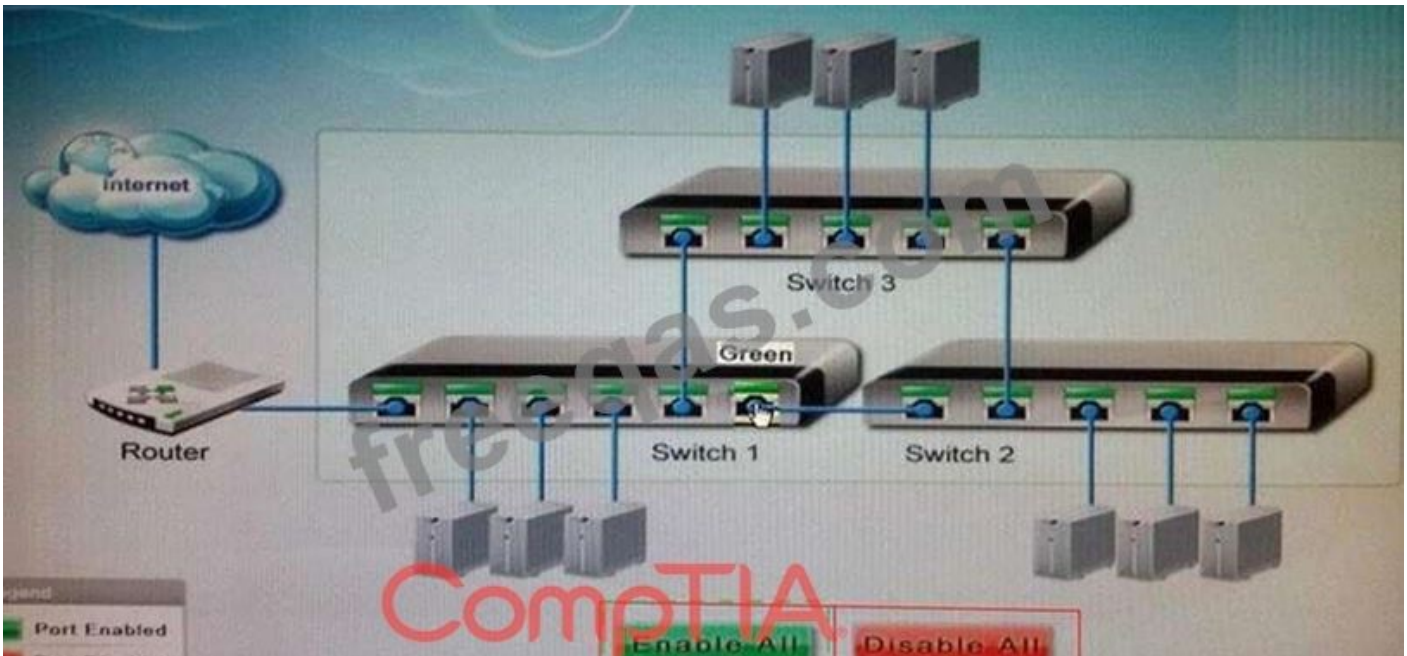

Explanation

All ports should be enabled.

NEW QUESTION: 126

Which of the follow creates a secure remote connection at the OSI network layer?

A. IPSec

B. DTLS

C. SSL

D. L2TP

Answer: ([SHOW ANSWER](#))

NEW QUESTION: 127

Given the table below:

Host Name	IP Address
Host A	192.168.10.22/24
Host B	192.168.10.23/24
Host C	192.168.11.125/24
Host D	192.168.11.53/24
Host E	192.168.5.15/24

Which of the following addresses can Host E send a packet to that will reach Hosts C and D, but not Hosts A and B?

A. 192.168.11.0

B. 192.168.11.255

C. 192.168.5.1

D. 192.168.255.255

Answer: B ([LEAVE A REPLY](#))

NEW QUESTION: 128

A technician is investigating an issue related to a single host that is unable to access the Internet. The technician records the following information: Host IP 169.254.1.10. The network IP address range on the DHCP server is 10.10.5.2-10.10.5.250 with a default gateway 10.10.5.1 and a DNS of 8.8.8.8. Which of the following should the technician perform to troubleshoot the issue?

A. Perform a traceroute command to identify the router that is not functioning.

B. Verify the host has physical connectivity and is on the correct VLAN.

C. Change the IP scope on the DHCP server to a public IP address range.

D. Configure the DNS address in the DHCP scope to a 10.10.5.0/24 address.

Answer: ([SHOW ANSWER](#))

NEW QUESTION: 129

A technician is installing and configuring a SOHO network from a DOCSIS compliant ISP. Which of the following requires installation at the customer's site?

A. Firewall

B. Access point

C. Modern

D. Bridge

Answer: ([SHOW ANSWER](#))

NEW QUESTION: 130

A network technician recently installed a new server on a network. The technician must ensure the server does not have any unnecessary services running. The IP address of the server is 204.211.38.50. Which of the following commands would allow the technician to make this determination?

- A. nslookup
- B. route
- C. nmap
- D. pathping

Answer: C ([LEAVE A REPLY](#))

NEW QUESTION: 131

A user checks an IP address using an external website. The address is different than the one the user sees when opening a command prompt and typing in ipconfig/all. The user does not understand why the two tools show different IP addresses. This is BEST explained by the interworking of:

- A. network devices
- B. packet flow
- C. public/private networks
- D. traffic-routing protocols

Answer: C ([LEAVE A REPLY](#))

NEW QUESTION: 132

Which of the following is networking stand-alone hardware that will permit any WIFI- compliant to connect to a wired network?

- A. Wireless hub
- B. Wireless firewall
- C. Wireless access point
- D. Wireless bridge

Answer: C ([LEAVE A REPLY](#))

NEW QUESTION: 133

Joe, a network technician, has received a report that one of his clients is experiencing an issue connecting to the network. Joe observes two clients are connected to a hub, which is connected to separate wall jacks. Which of the following has MOST likely occurred?

- A. Duplicate IP addresses
- B. Improperly tagged ports
- C. Switching loop

- D. ARP cache poisoning
- E. Wrong VLAN assignment

Answer: A ([LEAVE A REPLY](#))

NEW QUESTION: 134

Joe, a user, is having issues when trying to access certain web pages. Upon navigating to a web page, it seems like it connects, but then presents the following message:

```
The security certificate presented by this website was not trusted by a trusted certificate authority.
```

Joe has cleared his cache and cookies, rebooted his machine, and attempted to browse to the website from a coworker's desktop, but it still presented with this error.

Which of the following is the MOST likely cause of this error?

- A. The website is missing an HTTPS certificate.
- B. TLS is not enabled in the browser.
- C. The web server is missing an intermediate certificate.
- D. The SSL certificate has expired.

Answer: C ([LEAVE A REPLY](#))

NEW QUESTION: 135

Which of the following WAN technologies provides a guaranteed throughput rate?

- A. DSL
- B. T-1
- C. Cable broadband
- D. Dial-up

Answer: ([SHOW ANSWER](#))

NEW QUESTION: 136

Which of the following is the correct representation of an IPv6 address?

- A. 0:0:0:0:0:0:0:1
- B. 2001::4860:800f::
- C. ::
- D. 1:2:3:4:AB:CD:EF

Answer: C ([LEAVE A REPLY](#))

Valid N10-007 Dumps shared by PrepPdf.com for Helping Passing N10-007 Exam!
PrepPdf.com now offer the **newest N10-007 exam dumps**, the PrepPdf.com N10-007 exam questions have been updated and answers have been corrected get the **newest**

PrepPdf.com N10-007 dumps with Test Engine here:

<https://www.preppdf.com/CompTIA/N10-007-prepaway-exam-dumps.html> (690 Q&As Dumps,

40%OFF Special Discount: Exam-Tests)

NEW QUESTION: 137

Which of the following is the SHORTEST way to write 2001:0000:0d58:0000:0000:0095:7565:0001 in proper IPv6 shorthand?

- A. 2001::d58::95:7565:1
- B. 2001:0:d58:0:0:95:7565:1
- C. 2001:0:d58::95:7565:1
- D. 2001:0:0d58::95:7565:1

Answer: C ([LEAVE A REPLY](#))

NEW QUESTION: 138

While troubleshooting a connectivity issue, a network technician successfully pinged the loopback address and external DNS server but was unable to ping the website's URL. Which of the following tools should the technician use to determine where the network issue is located?

- A. netstat
- B. tracer
- C. Nmap
- D. ipconfig
- E. nslookup

Answer: B ([LEAVE A REPLY](#))

NEW QUESTION: 139

A customer is reporting difficulty connecting some devices after replacing a wireless router with a new

wireless 802.11ac router. The SSID, encryption and password are the same as the previous router. A

technician goes on-site and notices the devices that are no longer connecting appear to be several years

ago. Which of the following is MOST likely the problem?

- A. there is a security type mismatch.
- B. there is a frequency mismatch.
- C. the channel has changed.
- D. there is insufficient antenna power.
- E. the password needs to be re-entered.

Answer: B ([LEAVE A REPLY](#))

NEW QUESTION: 140

Which of the following provides information about how often some devices fail so the IT

department can take proactive measures?

- A. MTTR
- B. UPS
- C. SLA
- D. MTBF

Answer: D ([LEAVE A REPLY](#))

NEW QUESTION: 141

A network technician has recently installed new VoIP phones at all employee's desks to support a new SIP cloud VoIP solution. However, the technician is unable to make a call from the device after testing. Which of the following should the technician verify? (Choose two.)

- A. UDP 5060 is allowed.
- B. TCP 443 is allowed.
- C. TCP 8181 is allowed.
- D. TCP 8080 is allowed.
- E. UDP 1720 is allowed.
- F. UDP 5061 is allowed.

Answer: ([SHOW ANSWER](#)**)**

NEW QUESTION: 142

A technician is investigating the cause of a network outage. Which of the following documents should be checked to rule out configuration issues?

- A. Network log files
- B. Change management records
- C. Logical diagrams
- D. Inventory management

Answer: B ([LEAVE A REPLY](#))

NEW QUESTION: 143

A telecommunications provider has just deployed a new OC-12 circuit at a customer site. While the circuit showed no errors from the provider end to the customer's demarcation point, a network administrator is trying to determine the cause of dropped packets and errors on the circuit. Which of the following should

the network administrator do to rule out any problems at Layer 1? (Choose two.)

- A. Check for any devices that may be causing EMI on the cable
- B. Use an OTDR to validate the cable integrity
- C. Clean the cables to be sure they are free of dust and debris
- D. Use a pinout tester to validate the cable integrity

E. Use a loopback at the demark and router, and check for a link light

F. Use a multimeter to validate the cable integrity

Answer: B,E ([LEAVE A REPLY](#))

NEW QUESTION: 144

Which of the following security mechanisms dynamically assigns a Layer 2 address and restricts traffic only to that Layer 2 address?

A. Sticky MAC

B. 802.1x

C. ACL

D. NAC

Answer: A ([LEAVE A REPLY](#))

Section: (none)

NEW QUESTION: 145

Your company recently purchased a new building down the street from the existing office. For each of the tasks below, select the appropriate antenna type and encryption object for all wireless access point (AP).

1. Create an encrypted wireless connection between the two buildings that BEST controls signal propagation, while maximizing security.
2. Restrict the wireless signal generated by the access points (APs) inside Building 1, so that it minimizes broadcast beyond the building.
3. Maximize wireless coverage inside Building 1.
4. Building 1's internal wireless network is for visitors only and must not require any special configuration on the visitor's device to connect.

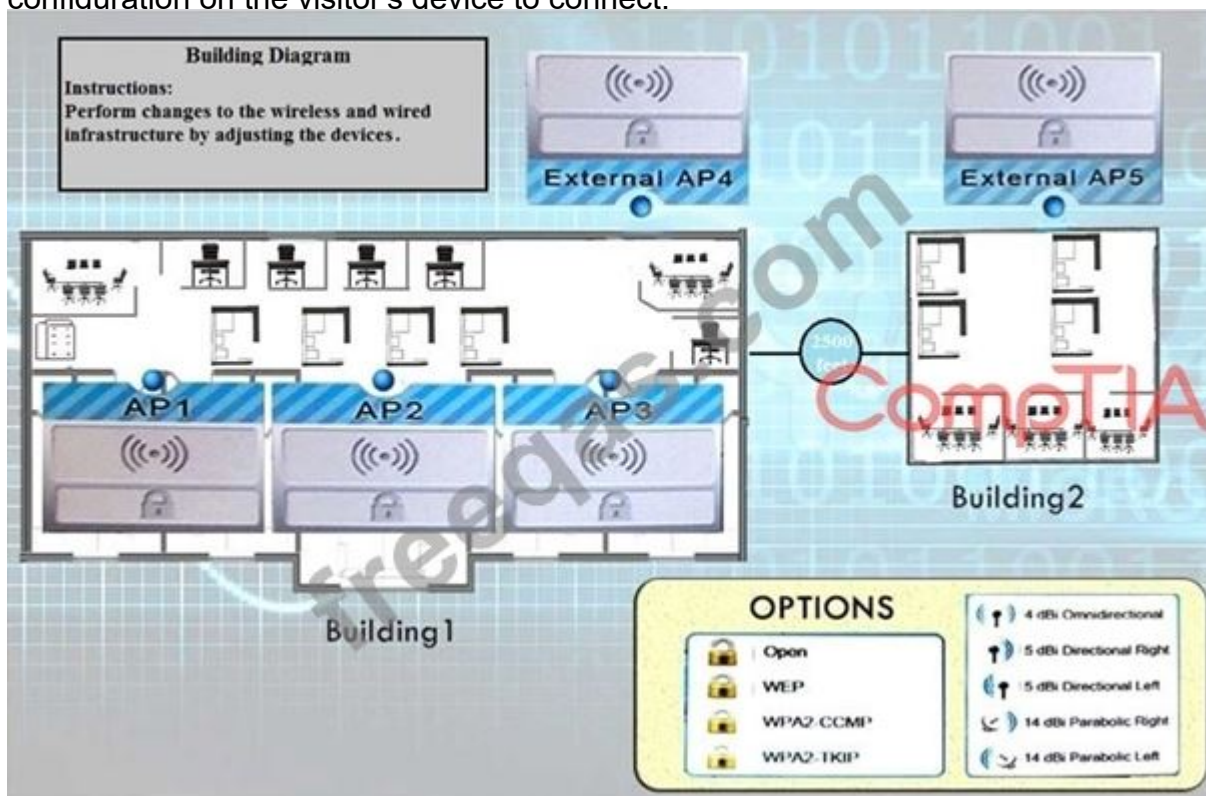

Instructions: When you have completed the simulation, select the Done button to submit.

Answer:

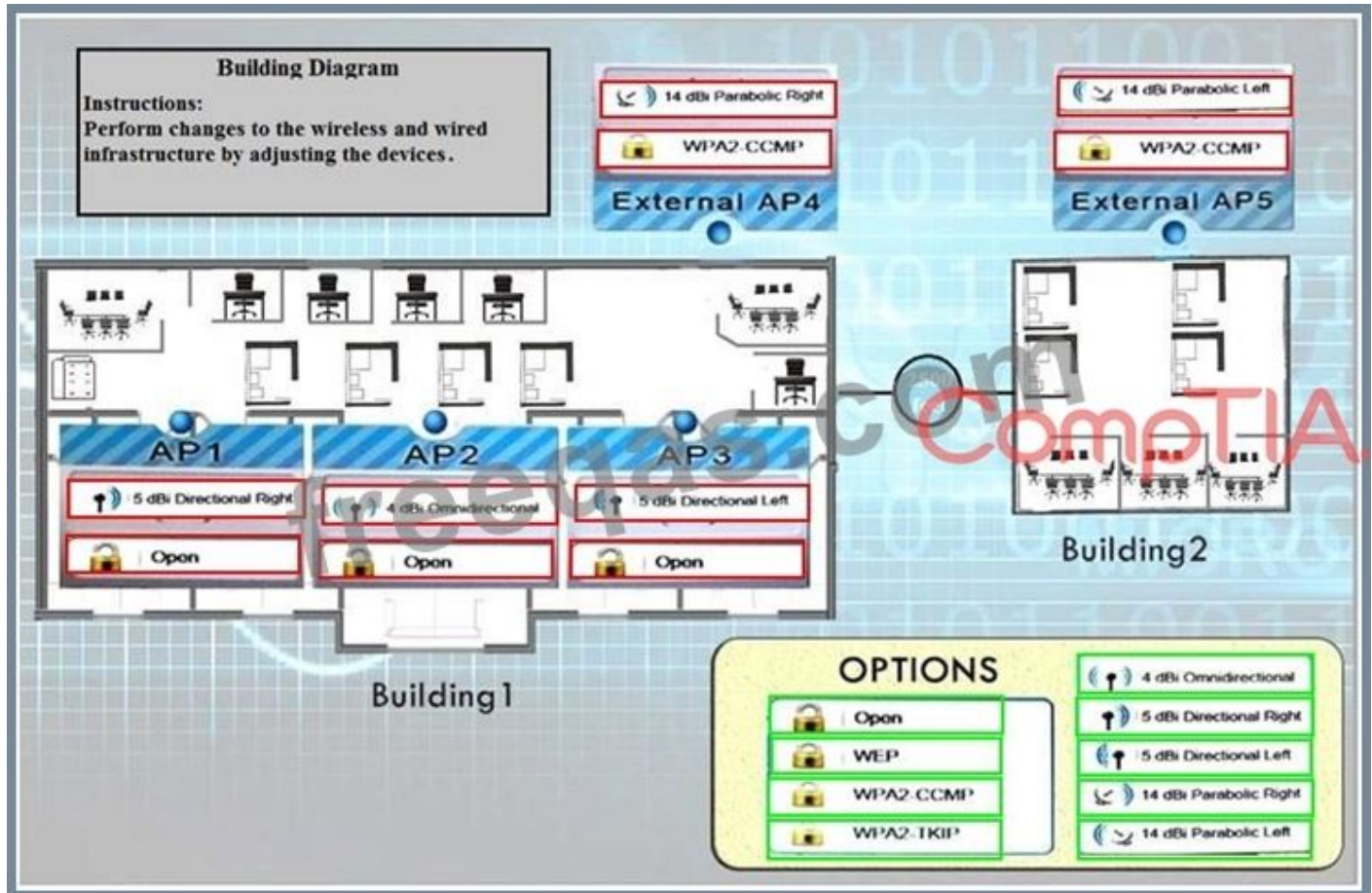

NEW QUESTION: 146

Multiple users are reporting that they are unable to access the network. The ENTIRE network is shown in the diagram. PCs are not statically assigned IP addresses. The following devices will display settings:

- * WorkstationA
- * WorkstationB
- * WorkstationC
- * WorkstationD
- * WorkstationE
- * WorkstationF
- * WorkstationG
- * Laptop1
- * Laptop2
- * DHCP server1
- * DHCP server2

Review the settings and select the box in the diagram that identifies the device causing the issue. Only one device can be selected at a time.

After checking the device that is causing the issue, select the second tab in the lower left hand corner. Identify the reason as to why some users are unable to access the network.

Instructions:

When the simulation is complete, select the Done button to submit.

Part 1

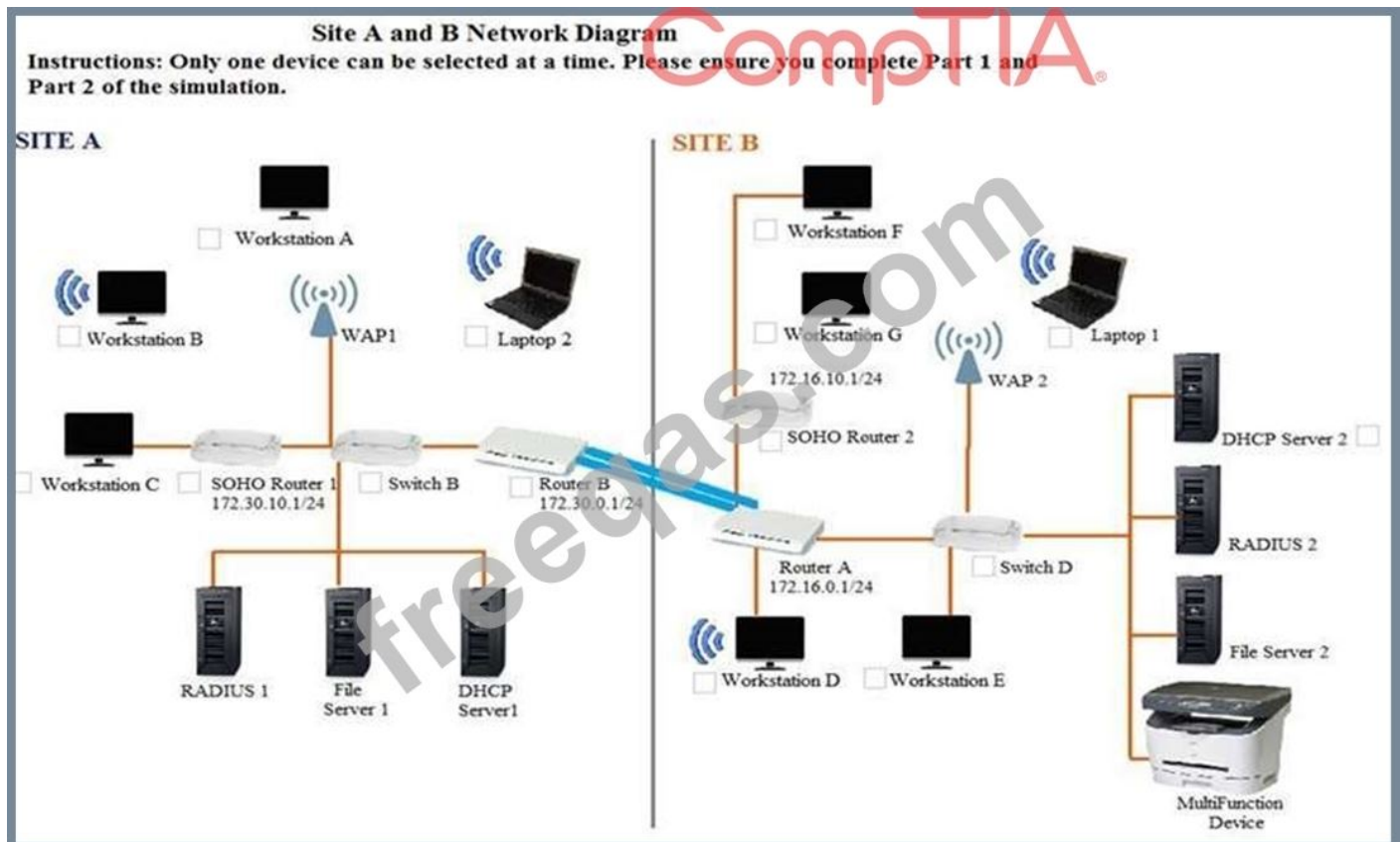

WORKSTATION A

IP Address	172.30.0.10
Netmask	255.255.255.0
Gateway	172.30.0.1

OK

WORKSTATION B

IP Address	172.30.0.14
Netmask	255.255.255.0
Gateway	172.30.0.1

OK

WORKSTATION C

IP Address	169.254.200.67
Netmask	255.255.255.0
Gateway	

OK

WORKSTATION D

IP Address	172.16.0.221
Netmask	255.255.255.0
Gateway	172.16.0.1

OK

WORKSTATION E

IP Address	172.16.0.21
Netmask	255.255.255.0
Gateway	172.16.0.1

OK

WORKSTATION F

IP Address	172.16.10.43
Netmask	255.255.255.0
Gateway	172.16.10.1

OK

WORKSTATION G

IP Address	172.16.10.120
Netmask	255.255.255.0
Gateway	172.16.10.1

OK

LAPTOP 1

IP Address	172.16.0.220
Netmask	255.255.255.0
Gateway	172.16.0.1

OK

LAPTOP 2

IP Address	172.30.0.12
Netmask	255.255.255.0
Gateway	172.30.0.1

DHCP SERVER 1

IP Address	172.30.0.5
Netmask	255.255.255.0
Gateway	172.30.0.1

DHCP Scope	172.30.0.10-250
Gateway	172.30.0.1
DNS Servers	10.200.2.20, 10.200.3.20
DHCP Lease Time	8 days

DHCP SERVER 2

IP Address	172.30.0.5
Netmask	255.255.255.0
Gateway	172.16.0.1

DHCP Scope	172.16.0.10-250
Gateway	172.16.0.1
DNS Servers	10.200.2.20, 10.200.3.20
DHCP Lease Time	8 days

Part 2

Identify the reason as to why some users are unable to access the network.

- A. STP has disabled some of the ports on the switch
- B. WAN and LAN ports are reversed on the router
- C. DHCP server scope is full and is not providing IP addresses
- D. The NIC driver is not installed
- E. A wireless client is unable to associate to the AP
- F. The site-to-site router was configured with the incorrect ACL
- G. Workstation(s) are plugged into switch ports configured with half duplex

Answer: ([SHOW ANSWER](#))

NEW QUESTION: 147

A technician is troubleshooting a server in the finance office that hosts an internal accounting program. The ticketing desk has received several calls from users reporting that access to the accounting program is degraded, and they are experiencing severe delays, sometimes timing out entirely. The problem has been isolated to the server. Which of the following tools should the technician use on the server to narrow down the issue?

- A. pathping
- B. iptables
- C. netstat
- D. nslookup

Answer: A ([LEAVE A REPLY](#))

NEW QUESTION: 148

Your company recently purchased a new building down the street from the existing office. For each of the tasks below, select the appropriate antenna type and encryption object for all wireless access point (AP).

1. Create an encrypted wireless connection between the two buildings that BEST controls signal propagation, while maximizing security.
2. Restrict the wireless signal generated by the access points (APs) inside Building 1, so that it minimizes broadcast beyond the building.
3. Maximize wireless coverage inside Building 1.
4. Building 1's internal wireless network is for visitors only and must not require any special configuration on the visitor's device to connect.

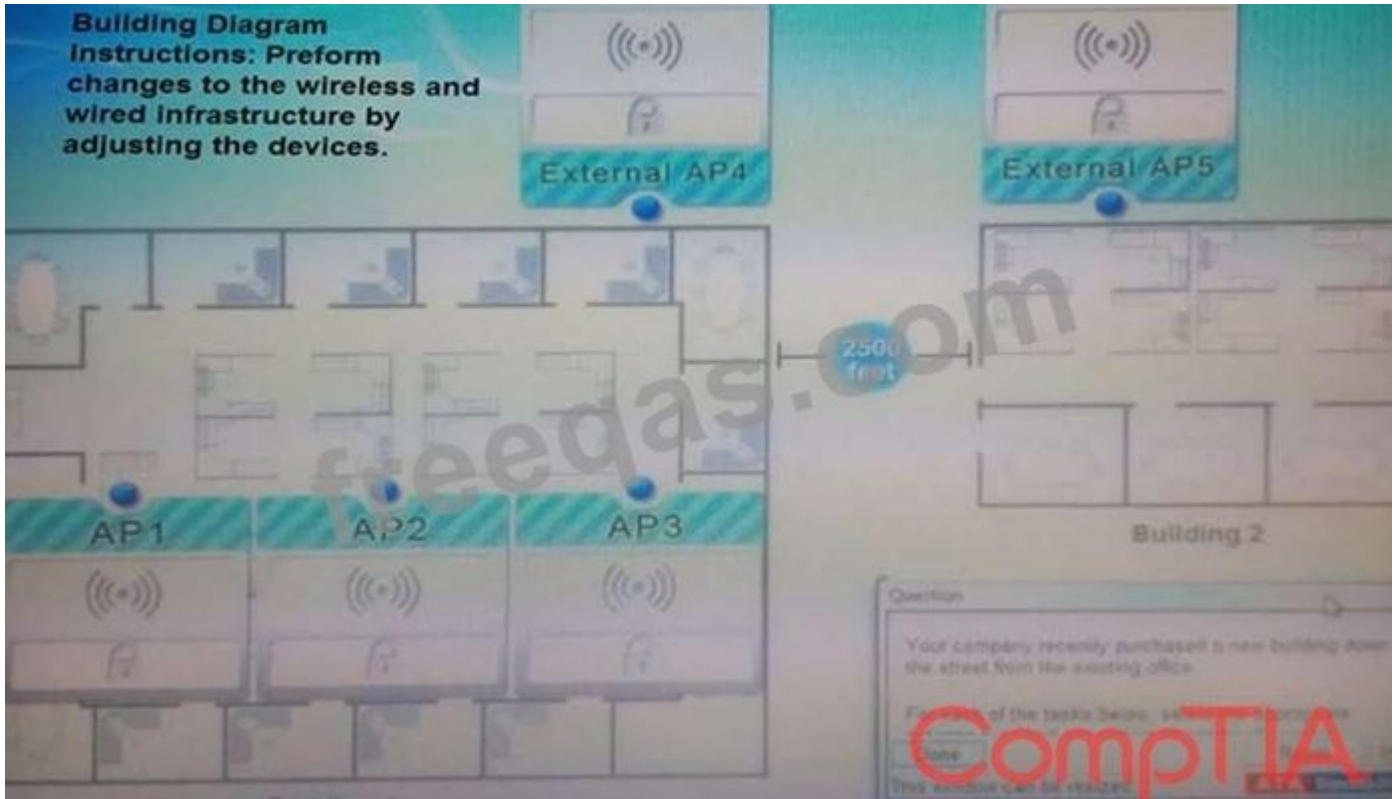

Instructions: When you have completed the simulation, select the Done button to submit.

Answer:

See explanation below.

Explanation.

Answer is as below in image.

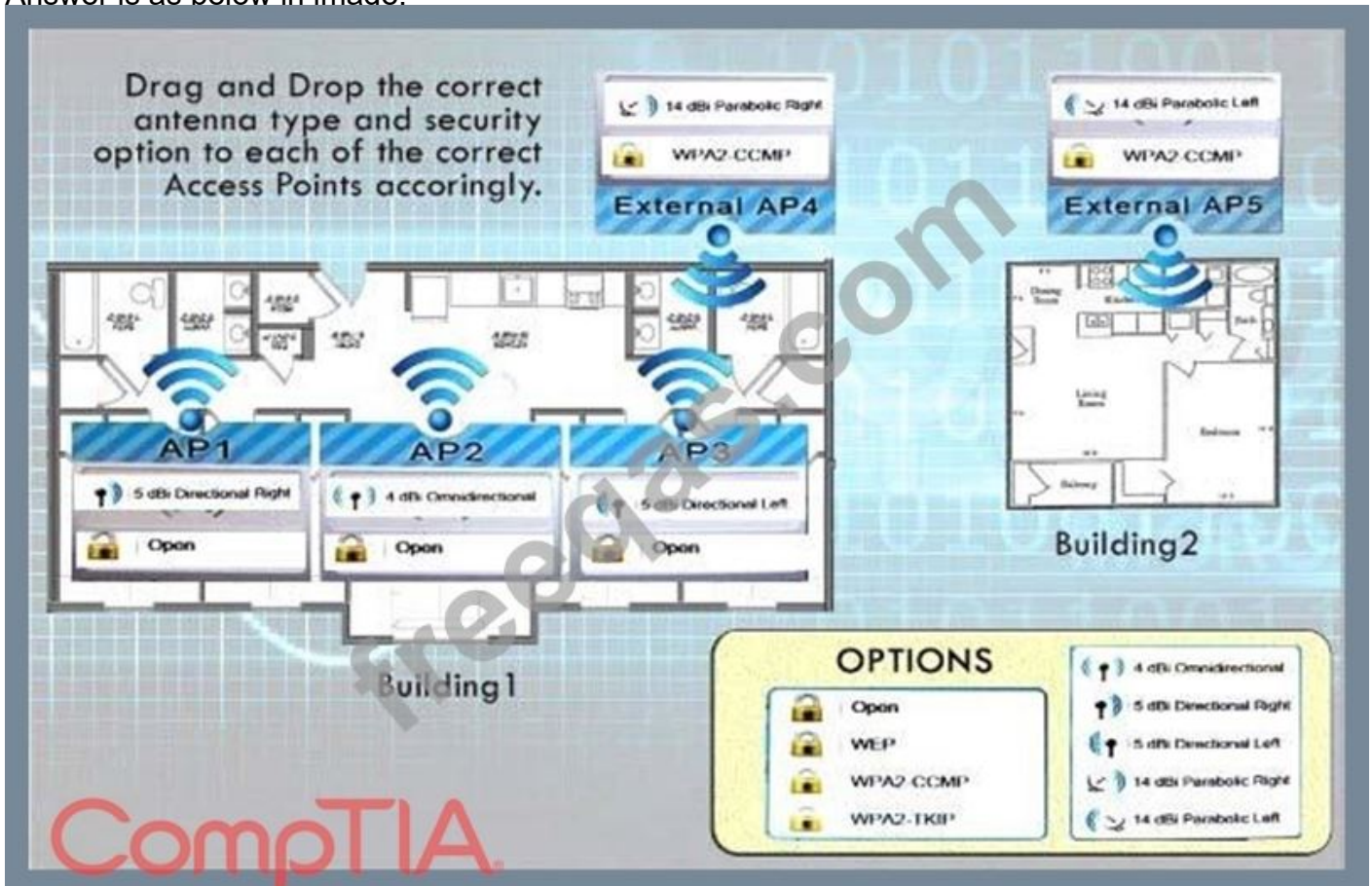

NEW QUESTION: 149

The backups server connects to a NAS device using block-level storage over Ethernet. The performance is very slow, however, and the network technician suspects the performance issues are network related.

Which of the following should the technician do to improve performance?

- A. Utilize UDP to eliminate packet overhead
- B. Turn off MDIX settings on the NAS and server switchports
- C. Enable jumbo frames on the NAS and server
- D. Encapsulate the storage traffic in a GRE tunnel

Answer: C ([LEAVE A REPLY](#))

Section: (none)

NEW QUESTION: 150

An IDS was installed behind the edge firewall after a network was breached. The network was then breached again even though the IDS logged the attack. Which of the following should be used in place of these devices to prevent future attacks?

- A. A proxy server
- B. A content filter
- C. A network tap
- D. A UTM appliance

Answer: ([SHOW ANSWER](#))

NEW QUESTION: 151

A technician is performing a maintenance task on a weekly basis and wants to ensure the task is properly

documented and able to be performed by other technicians. Which of the following types of documentation

should the technician complete?

- A. Change management
- B. Standard operating procedure
- C. Logical diagram
- D. Performance baseline
- E. Work order

Answer: B ([LEAVE A REPLY](#))

Valid N10-007 Dumps shared by PrepPdf.com for Helping Passing N10-007 Exam!
PrepPdf.com now offer the **newest N10-007 exam dumps**, the PrepPdf.com N10-007 exam **questions have been updated** and **answers have been corrected** get the **newest** PrepPdf.com N10-007 dumps with Test Engine here:
<https://www.preppdf.com/CompTIA/N10-007-prepaway-exam-dumps.html> (690 Q&As Dumps, **40%OFF Special Discount: Exam-Tests**)

NEW QUESTION: 152

Which of the following are standard fiber cable connector types? (Select TWO).

- A. DB-9
- B. ST
- C. MTRJ
- D. RJ-11
- E. F-connector

Answer: B,C ([LEAVE A REPLY](#))

NEW QUESTION: 153

A technician logs onto a system using Telnet because SSH is unavailable. SSH is enabled on the target device, and access is allowed from all subnets. The technician discovers a critical step was missed. Which of the following would allow SSH to function properly?

- A. Change default credentials
- B. Generate new keys
- ~~C. Update firmware~~
- ~~D. Perform file hashing~~

Answer: B ([LEAVE A REPLY](#))

NEW QUESTION: 154

Which of the following network topologies is ONLY possible between two users?

- A. Peer-to-peer
- B. Hybrid
- C. Star
- D. Client-server

Answer: A ([LEAVE A REPLY](#))

NEW QUESTION: 155

While working on a Linux-based OS, a technician experiences an issue accessing servers and some sites by name. Which of the following command-line tools should the technician use to assist in troubleshooting?

- A. ifconfig
- B. traceroute

C. iptables

D. dig

Answer: A ([LEAVE A REPLY](#))

NEW QUESTION: 156

A network technician is observing the behavior of an unmanaged switch when a new device is added to the network and transmits data. Which of the following BEST describes how the switch processes this information?

A. The data is flooded out of every port, including the one on which it came in.

B. The data is flooded out of every port but only in the VLAN where it is located.

C. The data is flooded out of every port, except the one on which it came in

D. The data is flooded out of every port, excluding the VLAN where it is located

Answer: ([SHOW ANSWER](#))

NEW QUESTION: 157

Your company recently purchased a new building down the street from the existing office. For each of the tasks below, select the appropriate antenna type and encryption object for all wireless access point (AP).

1. Create an encrypted wireless connection between the two buildings that BEST controls signal propagation, while maximizing security.

2. Restrict the wireless signal generated by the access points (APs) inside Building 1, so that it minimizes broadcast beyond the building.

3. Maximize wireless coverage inside Building 1.

4. Building 1's internal wireless network is for visitors only and must not require any special configuration on the visitor's device to connect.

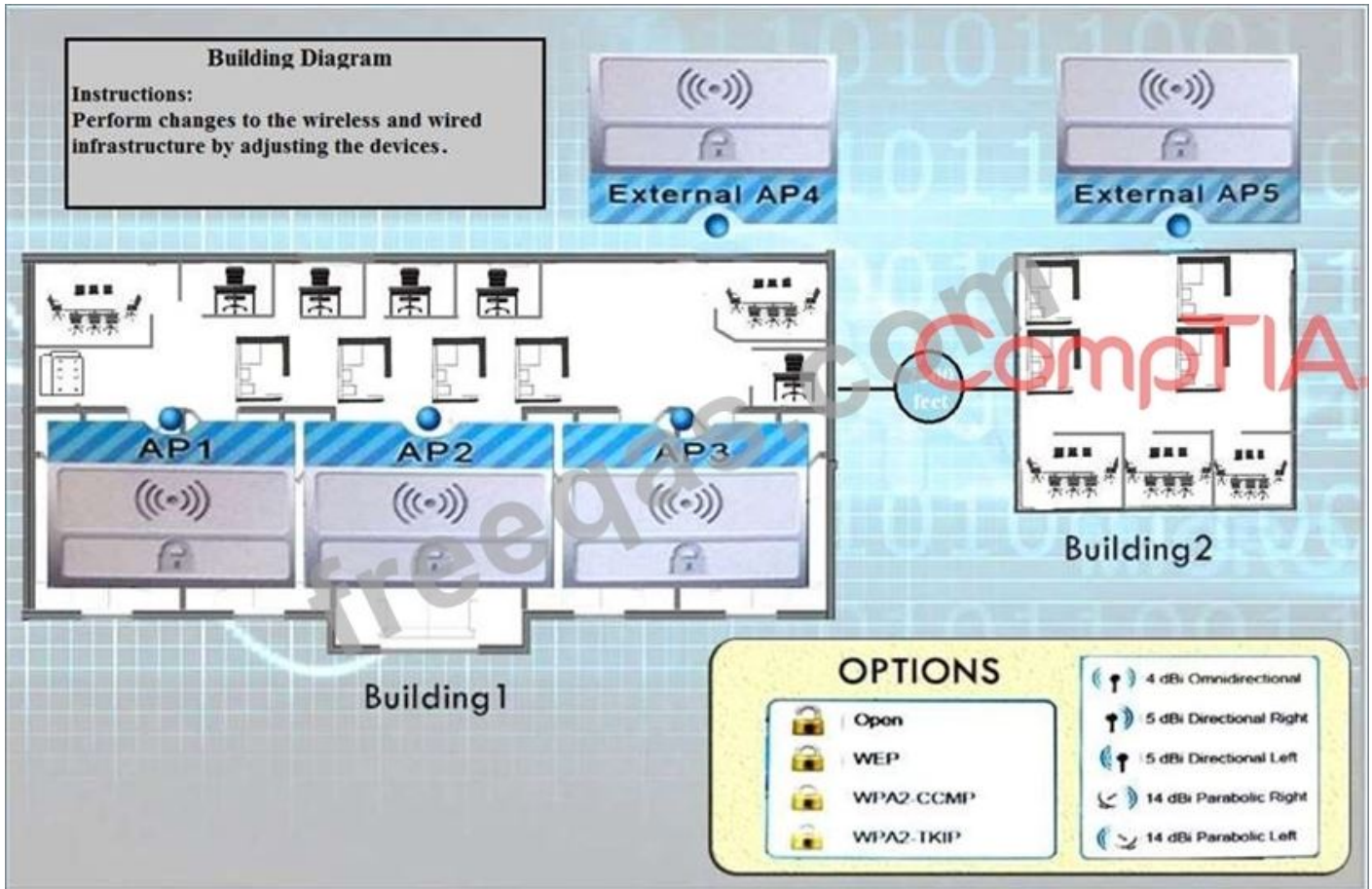

Instructions: When you have completed the simulation, select the Done button to submit.

Answer:

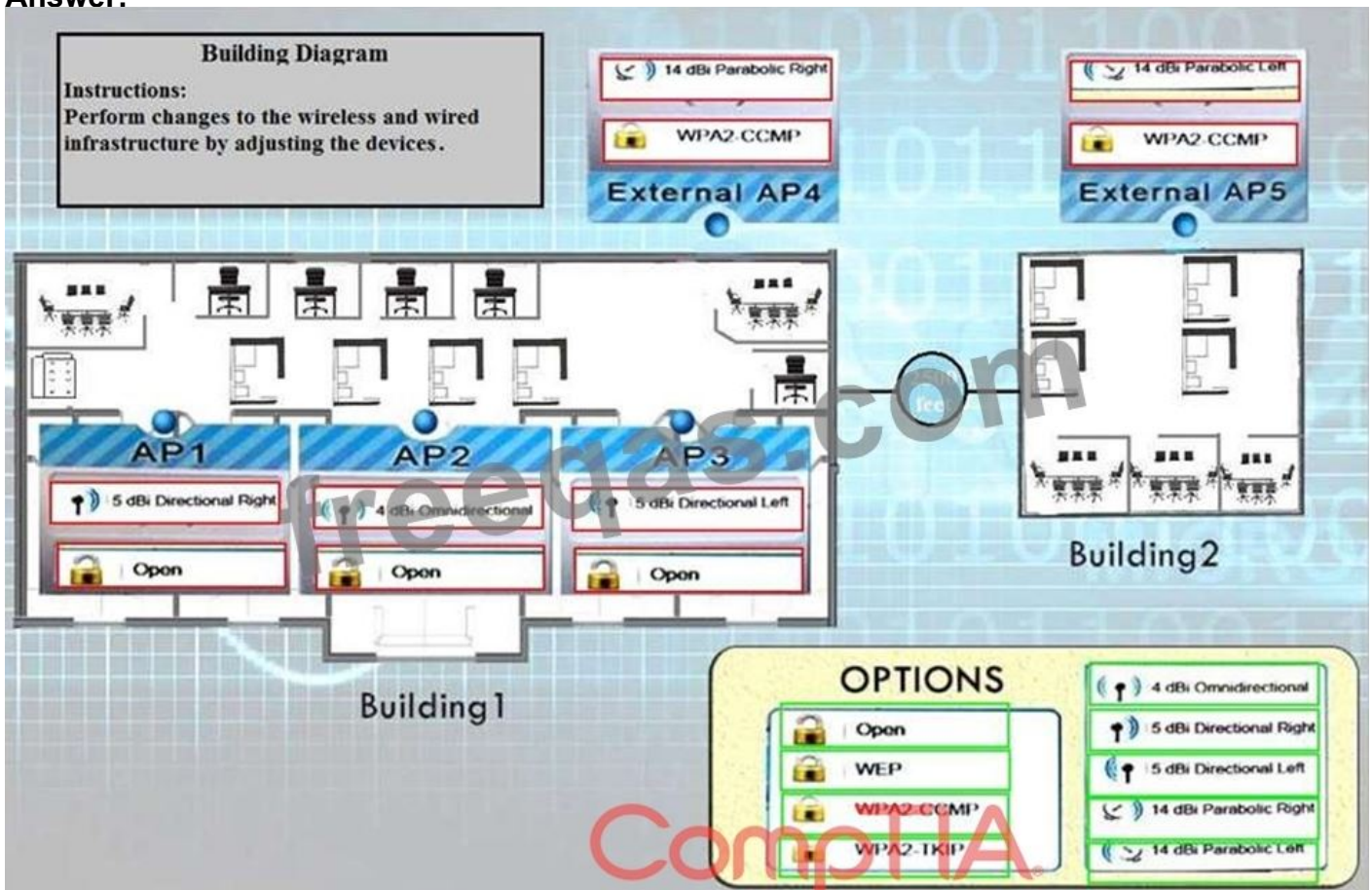

NEW QUESTION: 158

A technician is planning a remote-access strategy to manage routers and switches on a dedicated management network. The management network is segregated from the production network and uses site-to-site VPN connections. Some of the equipment does not support encryption, Which of the following should the technician choose that all the equipment would support?

- A. SSH
- B. SSL
- C. Telnet
- D. IPSec

Answer: C ([LEAVE A REPLY](#))

NEW QUESTION: 159

A network technician has just configured NAC for connections using Cat 6 cables. However, none of the Windows clients can connect to the network.

Which of the following components should the technician check on the Windows workstations? (Choose two.)

- A. Start the Wired AutoConfig service in the Services console
- B. Enable IEEE 802.1q Authentication in Network Interface Card Properties
- C. Enable IEEE 802.1x Authentication in Network Interface Card Properties
- D. Start the Wireless AutoConfig service in the Services console
- E. Enable IEEE 802.3 Ethernet IPv6 in Network Interface Card Properties

Answer: A,C ([LEAVE A REPLY](#))

Section: (none)

NEW QUESTION: 160

Which of the following backup techniques is used to capture all the data that has changed since the least full backup?

- A. Incremental
- B. Replica
- C. Different
- D. Snapshot

Answer: A ([LEAVE A REPLY](#))

Explanation

Notice that a differential backup is a cumulative backup. Because the archive bits are not set, it keeps backing up all changes since the last full backup. This means the backup files will get progressively larger throughout the week (assuming a standard weekly normal backup). The incremental backup, by contrast, only backs up files changed since the last full or incremental backup. Each incremental backup file will be relatively small and also totally different from the previous backup file.

NEW QUESTION: 161

A network technician is installing a new SOHO branch office that requires the use of a DOCSIS-compatible modem. The modem needs to be connected to the ISP's network at the demarc. Which of the following cable types should be used?

- A. Coaxial
- B. Multimode
- C. Serial
- D. UTP

Answer: A ([LEAVE A REPLY](#))

NEW QUESTION: 162

Which of the following BEST describes the difference between layer 2 switching and layer 2 routing?

- A. Both routing and switching move packets between hosts on the same subnet, but routing does so at a faster pace.
- B. Both routing and switching move packets between hosts on different subnets, but switching does so at a faster pace.
- C. Switching moves packets between hosts on different subnets, and routing moves packets between hosts on the same subnet.
- D. Routing moves packets between hosts on different subnets, and switching moves packets between hosts on the same subnet.

Answer: D ([LEAVE A REPLY](#))

NEW QUESTION: 163

A new OC3 experiencing intermittent connectivity and loss of signal alarms. A network administrator finds all the cables are properly connected. There is excess cable between the patch panel and the network node. The cables were forced into their storage compartments about the rack. Which of the following is MOST likely cause of the connectivity issue and alarms?

- A. The new OC3 cable is experiencing EMI.
- B. The bend radius of the cable has been exceeded.
- C. The cable was improperly crimped.
- D. The OC2 was improperly provisioned.

Answer: B ([LEAVE A REPLY](#))

NEW QUESTION: 164

After several changes to the network, a technician needs to ensure a client is checking for new hostname and IP pairings. Which of the following commands should the technician use to force new lookups?

- A. ipconfig /flushdns

- B. ipconfig /release
- C. ipconfig /renew
- D. ipconfig /all

Answer: ([SHOW ANSWER](#))

Explanation/Reference:

NEW QUESTION: 165

Users in the administration building of a multi-building campus are reporting loss of network connectivity. A network technician suspects conversation workers may have severed the link between the core switch located in the datacenter in the administration building's distribution switch. Which of the following tools should be used to identify where the break occurred?

- A. Tone generator
- B. FCoE
- C. Multimeter
- D. OTDR

Answer: A ([LEAVE A REPLY](#))

NEW QUESTION: 166

A network engineer is designing a new network for a remote site. The remote site consists of ten desktop computers, ten VoIP phones, and two network printers. In addition, two of the desktop computers at the remote site will be used by managers who should be on a separate network from the other eight computers. Which of the following represents the BEST configuration for the remote site?

- A. One router connected to one 24-port switch configured with three VLANs: one for the manager's computers and printer, one for the other computers and printer, and one for the VoIP phones
- B. Two routers with each router connected to a 12-port switch, with a firewall connected to the switch connected to the manager's desktop computers, VoIP phones, and printer
- C. One router connected to one 12-port switch configured for the manager's computers, phones, and printer, and one 12-port switch configured for the other computers, VoIP phones, and printer
- D. One router connected to one 24-port switch configured with two VLANs: one for the manager's computers, VoIP phones, and printer, and one for the other computers, VoIP phones, and printer

Answer: A ([LEAVE A REPLY](#))

Section: (none)

Valid N10-007 Dumps shared by PrepPdf.com for Helping Passing N10-007 Exam!
PrepPdf.com now offer the **newest N10-007 exam dumps**, the PrepPdf.com N10-007 exam **questions have been updated** and **answers have been corrected** get the **newest** PrepPdf.com N10-007 dumps with Test Engine here:
<https://www.preppdf.com/CompTIA/N10-007-prepaway-exam-dumps.html> (690 Q&As Dumps, **40%OFF Special Discount: Exam-Tests**)

NEW QUESTION: 167

A network topology requires a switch to be placed in an unsecured location. Which of the following techniques should be used to prevent unauthorized access? (Choose two.)

- A. File hashing
- B. MAC filtering
- C. Upgrading firmware
- D. Using secure protocols
- E. Disabling unused ports
- F. Configuring a honeypot

Answer: B,E ([LEAVE A REPLY](#))

NEW QUESTION: 168

The software in a virtualized environment that controls resource allocation and allows multiple operating system guests to run on the same physical platform is known as the:

- A. VDI.
- B. broker.
- C. hypervisor.
- D. LPAR.

Answer: C ([LEAVE A REPLY](#))

NEW QUESTION: 169

A technician is deploying a low-density wireless network and is contending with multiple types of building materials. Which of the following wireless frequencies would allow for the LEAST signal attenuation?

- A. 850MHz
- B. 5GHz
- C. 900MHZ
- D. 2.4GHz

Answer: B ([LEAVE A REPLY](#))

NEW QUESTION: 170

A network administrator wishes to ensure there are no unnecessary open communication paths into a server. Using a port scanner, the administrator finds that ports are reported as closed. Which of the following BEST explains this response?

- A. The ports replied with a SYN/ACK response
- B. The ports do not belong to a live system
- C. The ports belong to an active system and are denying requests
- D. The ports are associated with deprecated services

Answer: ([SHOW ANSWER](#))

NEW QUESTION: 171

Which of the following is the number of broadcast domain that are created when using an unmanaged 12-port switch?

- A. 1
- B. 0
- C. 12
- D. 2
- E. 6

Answer: ([SHOW ANSWER](#))

NEW QUESTION: 172

Which of the following should current network performance be compared against to determine network anomalies?

- A. Baseline
- B. Traffic analysis
- C. Packet capture
- D. Logs

Answer: A ([LEAVE A REPLY](#))

Section: (none)

NEW QUESTION: 173

A network technician needs to distribute an updated OS for all network switches at company locations throughout the world. The technician wants to ensure file integrity since several locations do not have high- quality connectivity to the Internet.

Which of the following methods should be used to distribute the images while ensuring integrity?

- A. Use an HTTP server to share the file.
- B. Use a modem and dial-up connection.
- C. Use an FTP server and provide the file hash.
- D. Use a TFTP server and UDP protocol.

Answer: C ([LEAVE A REPLY](#))

NEW QUESTION: 174

Which of the following steps is a network technician MOST likely to take to secure a new network printer?

(Choose two.)

- A. Secure the physical access.
- B. Generate new encryption keys.
- C. Enable HTTPS access.
- D. Turn on WPS.
- E. Change the default credentials.
- F. Disable unnecessary services.

Answer: E,F (LEAVE A REPLY)

NEW QUESTION: 175

A network engineer is designing a new network for a remote site. The remote site consists of ten desktop computers, ten VoIP phones, and two network printers. In addition, two of the desktop computers at the remote site will be used by managers who should be on a separate network from the other eight computers. Which of the following represents the BEST configuration for the remote site?

- A. Two routers with each router connected to a 12-port switch, with a firewall connected to the switch connected to the manager's desktop computers, VoIP phones, and printer
- B. One router connected to one 24-port switch configured with two VLANs: one for the manager's computers, VoIP phones, and printer, and one for the other computers, VoIP phones, and printer
- C. One router connected to one 24-port switch configured with three VLANs: one for the manager's computers and printer, one for the other computers and printer, and one for the VoIP phones
- D. One router connected to one 12-port switch configured for the manager's computers, phones, and printer, and one 12-port switch configured for the other computers, VoIP phones, and printer

Answer: C (LEAVE A REPLY)

NEW QUESTION: 176

A network administrator frequently needs to assist users with troubleshooting network hardware remotely, but the users are non-technical and unfamiliar with network devices. Which of the following would BEST help the administrator and users during hands-on troubleshooting?

- A. Standard operating procedures
- B. Equipment labeling
- C. Logical diagrams
- D. MDF documentation

Answer: A (LEAVE A REPLY)

NEW QUESTION: 177

A technician has been alerted of incoming HTTP traffic on the LAN segment that should not contain any web servers. The technician has the IP address of the destination host and wants to determine if the socket for HTTP is open. Which of the following should the technician perform?

- A. Patch-level assessment

- B. Packet analysis
- C. Baseline assessment
- D. Port scan

Answer: D ([LEAVE A REPLY](#))

NEW QUESTION: 178

A network technician needs a way to centrally manage and authenticate users. Which of the following would be BEST for this purpose?

- A. A proxy server
- B. Port security
- C. A RADIUS server
- D. A captive portal

Answer: C ([LEAVE A REPLY](#))

NEW QUESTION: 179

When querying a DNS server for an AAAA record, which of the following is an appropriate response?

- A. 61.23.168.192.in-addr.arpa
- B. 3ffe:1900:4545:3:200:f8ff:fe21:67cf
- C. 192.168.2.1
- D. 00:f3:82:99:a2:b8

Answer: ([SHOW ANSWER](#)**)**

A technician has been assigned to capture packets on a specific switchport. Which of the following switch features MUST be used to accomplish this?

- A. Port aggregation
- B. Spanning tree
- C. Trunking
- D. Port mirroring

Answer: D ([LEAVE A REPLY](#))

NEW QUESTION: 181

A new technician has been tasked with checking the status of a switchport. The technician needs to find the information quickly without the use of command-line utilities. Which of the following remote management methods would help the technician?

- A. SSH
- B. HTTPS
- C. RDP
- D. VNC

Answer: ([SHOW ANSWER](#)**)**

Valid N10-007 Dumps shared by PrepPdf.com for Helping Passing N10-007 Exam!
PrepPdf.com now offer the **newest N10-007 exam dumps**, the PrepPdf.com N10-007 exam **questions have been updated** and **answers have been corrected** get the **newest** PrepPdf.com N10-007 dumps with Test Engine here:
<https://www.preppdf.com/CompTIA/N10-007-prepaway-exam-dumps.html> (690 Q&As Dumps, **40%OFF Special Discount: Exam-Tests**)

NEW QUESTION: 182

An administrator is moving to a new office. There will be several network runs through the ceiling area of the office. Which of the following is the BEST to utilize in these areas?

- A. Single-mode fiber-optic cabling
- B. Cat 5e-rated cabling
- C. Cat 6-rated cabling
- D. Plenum-rated cabling

Answer: D (LEAVE A REPLY)

Section: (none)

NEW QUESTION: 183

Which of the following BEST explains the purpose of signature management as a mitigation technique?

- A. Segmenting the network
- B. Hardening devices
- C. Restricting user credentials
- D. Detecting malicious activity

Answer: D (LEAVE A REPLY)

NEW QUESTION: 184

Which of the following should be performed on a regular basis to prevent unauthorized access to a company network? (Choose two.)

- A. Packet analysis
- B. Log archiving
- C. Patch management
- D. Reviewing baselines
- E. Vulnerability scanning

Answer: C,E (LEAVE A REPLY)

NEW QUESTION: 185

A network technician is connecting two switches together. Which of the following protocols should the technician use to increase speed and fault tolerance?

- A. SIP

- B. BGP
- C. LACP
- D. LLDP

Answer: C ([LEAVE A REPLY](#))

Section: (none)

NEW QUESTION: 186

You have been tasked with testing a CAT5e cable. A summary of the test results can be found on the screen.

Step 1: Select the tool that was used to create the cable test results.

Step 2: Interpret the test results and select the option that explains the results. After you are done with your analysis, click the 'Submit Cable Test Analysis' button.

The screenshot displays a simulation interface for testing a CAT5e cable. The main window is titled "Cable Crimp" and contains the following text:

Instructions: You have determined that the original crimp is faulty using the T568B cabling standard. Drag the appropriate tool to the crimp. When you are finished, click the Done button.

The interface shows a cross-section of a cable with eight conductors and an RJ-45 connector. The conductors are numbered 1 through 8 and color-coded as follows:

- 1: Yellow
- 2: Orange
- 3: Green
- 4: Blue
- 5: Light Blue
- 6: Red
- 7: Brown
- 8: Black

The RJ-45 connector is shown with eight pins. A "Question" dialog box is open in the top right corner, containing the following text:

Question:
You have been tasked with testing a CAT5e cable. A summary of the test results can be found on the screen.

Step 1: Select the tool that was used to create the cable test results.

Step 2: Interpret the test results and select the option that explains the results. After you are done with your analysis, click the 'Submit Cable Test Analysis' button.

The dialog box has buttons for "Done", "Reset", and "Help". At the bottom of the dialog box, it says "This window can be resized." and "ATA: Simulate".

At the bottom of the main window, there is a "Reset Cable" button and the "CompTIA" logo.

Cable Test

Step 1: Select the tool that was used to create the cable test results.

Cable Test Result		
1, 2	Open	7ft
3, 6	Short	7ft
4, 5	Open	7ft
7, 8	Open	7ft



Tool Choices	
<input type="checkbox"/>	Crimper
<input type="checkbox"/>	Cable Certifier
<input type="checkbox"/>	Multimeter
<input type="checkbox"/>	Punch Down Tool
<input type="checkbox"/>	Protocol Analyzer
<input type="checkbox"/>	OTDR
<input type="checkbox"/>	Toner Probe

Answer:

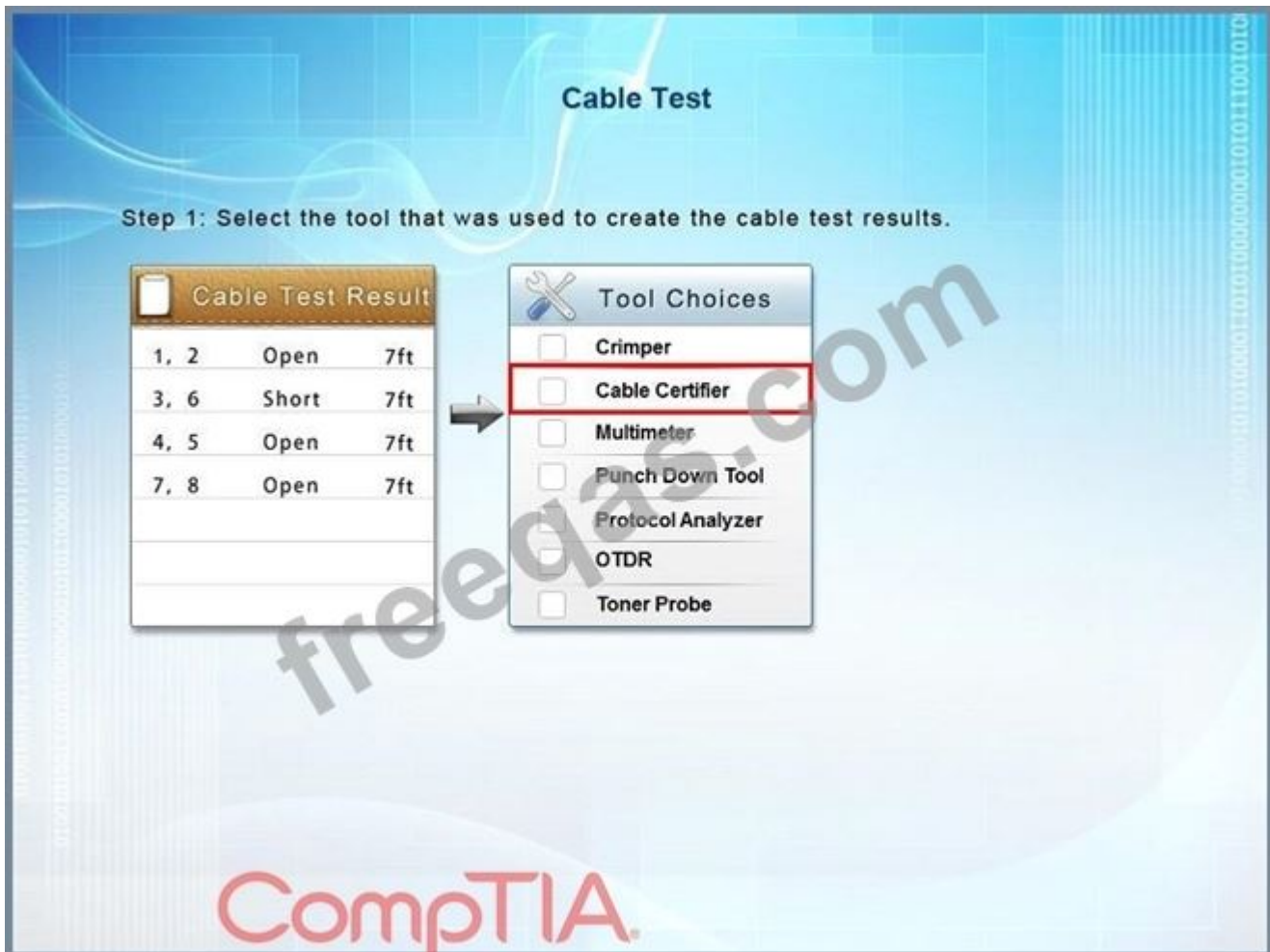

Explanation:

A Cable Certifier provides "Pass" or "Fail" information in accordance with industry standards but can also show detailed information when a "Fail" occurs. This includes shorts, the wire pairs involved and the distance to the short. When a short is identified, at the full length of the cable it means the cable has not been crimped correctly.

NEW QUESTION: 187

A network technician receives a call from a branch office about a problem with its wireless connectivity. The user states the office is hosting a large meeting that includes some online training with local businesses. The guest users have all brought devices to connect to the guest network at the branch office. All users are connected to a single WAP and are reporting that connections keep dropping and network spends are unusable. Which of the following is the MOST likely cause of this issue?

- A. DHCP exhaustion
- B. Interference
- C. Channel overlapping
- D. Overcapacity

Answer: D ([LEAVE A REPLY](#))

NEW QUESTION: 188

A company has decided to upgrade its legacy phone system to VoIP. The new phones will download the configurations from a TFTP server each time they boot up. Which of the following firewall ports must be opened to ensure the phones can communicate with the server?

- A. 161
- B. 53
- C. 69
- D. 20

Answer: C ([LEAVE A REPLY](#))

NEW QUESTION: 189

You have been tasked with testing a CAT5e cable. A summary of the test results can be found on the screen.

Step 1: Select the tool that was used to create the cable test results.

Step 2: Interpret the test results and select the option that explains the results. After you are done with your analysis, click the 'Submit Cable Test Analysis' button.

Cable Crimp

Instructions: You have determined that the original crimp is faulty using the T568B cabling standard. Drag the appropriate tool to the cable. When you are finished, click the Done button.

RJ-45 Connector

1	Orange
2	Yellow
3	Green
4	Blue
5	Light Blue
6	Light Green
7	Light Orange
8	Light Brown

Question

You have been tasked with testing a CAT5e cable. A summary of the test results can be found on the screen.

Step 1: Select the tool that was used to create the cable test results.

Step 2: Interpret the test results and select the option that explains the results. After you are done with your analysis, click the 'Submit Cable Test Analysis' button.

Done Reset Help

This window can be resized. ATA Simulation

Reset Cable

Cable Test

Step 1: Select the tool that was used to create the cable test results.

Cable Test Result		
1, 2	Open	7ft
3, 6	Short	7ft
4, 5	Open	7ft
7, 8	Open	7ft

Tool Choices	
<input type="checkbox"/>	Crimper
<input type="checkbox"/>	Cable Certifier
<input type="checkbox"/>	Multimeter
<input type="checkbox"/>	Punch Down Tool
<input type="checkbox"/>	Protocol Analyzer
<input type="checkbox"/>	OTDR
<input type="checkbox"/>	Toner Probe

Answer:

Cable Test

Step 1: Select the tool that was used to create the cable test results.

Cable Test Result		
1, 2	Open	7ft
3, 6	Short	7ft
4, 5	Open	7ft
7, 8	Open	7ft

Tool Choices	
<input type="checkbox"/>	Crimper
<input checked="" type="checkbox"/>	Cable Certifier
<input type="checkbox"/>	Multimeter
<input type="checkbox"/>	Punch Down Tool
<input type="checkbox"/>	Protocol Analyzer
<input type="checkbox"/>	OTDR
<input type="checkbox"/>	Toner Probe

Explanation

Cable Test

Step 1: Select the tool that was used to create the cable test results.

Cable Test Result

1, 2	Open	7ft
3, 6	Short	7ft
4, 5	Open	7ft
7, 8	Open	7ft

→

Tool Choices

- Crimper
- Cable Certifier
- Multimeter
- Punch Down Tool
- Protocol Analyzer
- OTDR
- Toner Probe

Step 2: Interpret the test results and select the option that explains the results.
After you are done with your analysis, click the 'Submit Cable Test Analysis' button.

Correctly crimped cable
 Incorrectly crimped cable

CompTIA

A Cable Certifier provides "Pass" or "Fail" information in accordance with industry standards but can also show detailed information when a "Fail" occurs. This includes shorts, the wire pairs involved and the distance to the short. When a short is identified, at the full length of the cable it means the cable has not been crimped correctly.

NEW QUESTION: 190

A network technician has salvaged several Ethernet cables from a datacenter. The technician attempts to use the cables to connect desktops to the network without success. Which of the following is MOST likely the issue?

- A. The cables are not plenum rated.
- B. The cables have an incorrect pin-out.
- C. The cables are UTP instead of STP.
- D. The cables are Cat 6 instead of Cat 5.

Answer: B ([LEAVE A REPLY](#))

NEW QUESTION: 191

Ann, a customer, recently upgraded her SOHO Internet to gigabit fiber from cable. She was previously getting speeds around 75Mbps down and 25Mbps up. After the upgrade, Ann runs a speed test on her desktop and gets results of 1000Mbps down and 100Mbps up. A technician connects directly to the router and sees the correct 1000Mbps speeds. Which of the following is MOST likely the cause? (Choose two.)

- A. Signal attenuation on the new fiber has reached the upper limits.
- B. The connections are using Cat 6 cable.
- C. There is a transceiver mismatch at the fiber termination point.
- D. There is a 10/100 switch on the network.
- E. All ports should be configured for full duplex.
- F. The connections are using Cat 5 cable.

Answer: E,F ([LEAVE A REPLY](#))

NEW QUESTION: 192

Management has requested that services be available within 72 hours of disaster, Budget is a major concern. A contract is signed with a company that has plenty space, and the technician will have the option of putting infrastructure equipment in place. Which of the following BEST describes this business continuity strategy?

- A. Warm site
- B. Full backup
- C. Hot site
- D. Differentiate backup
- E. Cold site
- F. Incremental backup

Answer: E ([LEAVE A REPLY](#))

NEW QUESTION: 193

The IT manager at a small firm is in the process of renegotiating an SLA with the organization's ISP. As part of the agreement, the organization will agree to a dynamic bandwidth plan to provide 150Mbps of bandwidth. However, if the ISP determines that a host on the organization's internal network produces malicious traffic, the ISP reserves the right to reduce available bandwidth to 1.5 Mbps. Which of the following policies is being agreed to in the SLA?

- A. Blocking
- B. Session hijacking
- C. Throttling
- D. Data usage limits
- E. Bandwidth quotas

Answer: C ([LEAVE A REPLY](#))

NEW QUESTION: 194

A technician replaces a customer's router, and is now unable to ping the ISP's gateway. Which of

the following should the technician check?

- A. The arp table of the new customer's router.
- B. The route table of the next-hop router.
- C. The route table of the new customer's router.
- D. The arp table of a network user.

Answer: C (LEAVE A REPLY)

NEW QUESTION: 195

A new employee is unable to access any network resources. All other users are able to access the network at

100Mbps No IP address, subnet mask or default gateway is displayed on the new employee's workstation The network administrator determinates all connectors using the correct standard Upon further investigation the network administrator also notices the following:

Wire map results from the user patch cable lo the patch cable connecting to the switch:

- * Pins 5 and 7 are short
- * The distance is 200ft (61m)

Additional observations on the switch

- * The VLAN is set correctly
- * The port is not disabled
- * The duplex "speed settings are correct
- * Port LEOs are off for that port.
- * The port is set to untagged.

Which of the following is the MOST likely reason the new employee is having network issues?

- A. Bad switchport
- B. Open/short
- C. VLAN mismatch
- D. Incorrect pinout
- E. Distance limitation

Answer: A (LEAVE A REPLY)

NEW QUESTION: 196

A technician needs to add ten additional Ethernet ports to a small office network. A new basic function switch is added. Hosts connected to the new switch are unable to see any computers on the network other than those connected to the new switch. Which of the following should the technician perform to ensure the hosts on the new switch can communicate with the existing network?

- A. Add a second cable connecting the switches for redundancy and disabling STP on both switches.
- B. Replace the new switch with a hub to ensure Layer 1 connectivity on the new network segment.
- C. Move the straight-through Ethernet cable connecting the switches to the first port on both

switches.

D. Connect the switches with a cable that has a TIA/EIA 586A wired connector end and a TIA/EIA 586B wired end.

Answer: D ([LEAVE A REPLY](#))

Valid N10-007 Dumps shared by PrepPdf.com for Helping Passing N10-007 Exam! PrepPdf.com now offer the **newest N10-007 exam dumps**, the PrepPdf.com N10-007 exam **questions have been updated** and **answers have been corrected** get the **newest** PrepPdf.com N10-007 dumps with Test Engine here:
<https://www.preppdf.com/CompTIA/N10-007-prepaway-exam-dumps.html> (**690** Q&As Dumps, **40%OFF** Special Discount: **Exam-Tests**)

NEW QUESTION: 197

A network technician receives a request for a disaster recovery solution. Management has requested no downtime in the event of a disaster. Which of the following disaster recovery solutions is the appropriate choice?

- A. Business continuity
- B. Virtual snapshot
- C. File backups
- D. Hot site

Answer: ([SHOW ANSWER](#)**)**

NEW QUESTION: 198

An administrator is troubleshooting a user's intermittent wireless connectivity issue. Other users across the hallway can connect and use the wireless network properly. Upon inspection of the connection details, the administrator finds the following:

SSID	Company-WiFi
Signal	5%
SNR	2

Which of the following is MOST likely the cause of the poor wireless connection?

- A. Channel overlap
- B. Latency
- C. Overcapacity
- D. Incorrect antenna type

Answer: ([SHOW ANSWER](#)**)**

NEW QUESTION: 199

Which of the following MUST be kept synchronized in order for Kerberos to work?

- A. Time

- B. Certificate
- C. Token
- D. Ticket

Answer: A ([LEAVE A REPLY](#))

NEW QUESTION: 200

A company wants to provide its sales representatives with an easy-to-use method of securely connecting to the corporate network from any client network. Which of the following methods should the network technician implement?

- A. Install VNC clients on the sales representatives' machines.
- B. Place all servers in the publicly available DMZ
- C. Allow RDP connections through the firewall.
- D. Create an SSL VPN for remote access to the network

Answer: D ([LEAVE A REPLY](#))

NEW QUESTION: 201

A technician logs onto a system using Telnet because SSH is unavailable. SSH is enabled on the target device, and access is allowed from all subnets the technician discovers a critical step was missed. Which of the following would allow SSH to function properly?

- A. Change default credentials.
- B. Update firmware.
- C. Generate new keys.
- D. Perform file hashing.

Answer: B ([LEAVE A REPLY](#))

NEW QUESTION: 202

A technician is troubleshooting intermittent connectivity on a line-of-sight wireless bridge. Which of the following tools should the technician use to determine the cause of the packet loss?

- A. Packet sniffer
- B. OTDR
- C. Spectrum analyzer
- D. Multimeter

Answer: C ([LEAVE A REPLY](#))

NEW QUESTION: 203

A technician is installing two new servers that collect logs. After installing the servers, the technician reviews the logical output from various commands. Which of the following should be included in a logical network diagram?

- A. Media type
- B. Room number
- C. Hostname
- D. Rack location

Answer: C ([LEAVE A REPLY](#))

NEW QUESTION: 204

A network administrator notices a wireless network with the SSID HOME-33BC-5G that has a high signal strength and open authentication. When the administrator connects to the SSID corporate servers can be accessed. Which of the following has the network administrator discovered?

- A. Man in the middle
- B. Wardriving
- C. Spoofing
- D. Evil twin
- E. Rogue AP

Answer: ([SHOW ANSWER](#))

NEW QUESTION: 205

A user calls the help desk for assistance with setting up a new SOHO router. The user has three employees who all have laptops that need to connect to the wireless network. The users need to have firewall rules allowing access to an internal server but cannot be configured with static IP addresses. Which of the following BEST describes what the technician should implement?

- A. DHCP reservation for the laptops' MACs
- B. CNAME record in the users' dynamic DNS accounts
- C. IP helper relay system for configuration hops
- D. Additional lease time for the laptop computers

Answer: ([SHOW ANSWER](#))

NEW QUESTION: 206

When configuring a new switch in a packet-switched network which of the following helps protect against network loops?

- A. DHCP snooping
- B. Flood guard
- C. BPDU guard
- D. Spanning tree

Answer: D ([LEAVE A REPLY](#))

NEW QUESTION: 207

A network technician is installing and configuring a new router for the sales department. Once the task is complete, which of the following needs to be done to record the change the technician is making to the company network?

- A. Change management
- B. Network diagrams
- C. Inventory report

D. Labeling report

Answer: A ([LEAVE A REPLY](#))

Explanation

NEW QUESTION: 208

To replace a defective UPS, the network administrator must take the switch offline. The administrator wants to be able to perform maintenance UPS in the future without affecting the availability of the attached switch. Which of the following would BEST allow this to happen?

- A. Implement stacking on the switches in the rack
- B. Add a second UPS into the rack
- C. Install a power converter for the switch
- D. Add a redundant power supply to the switch

Answer: ([SHOW ANSWER](#))

NEW QUESTION: 209

You have been tasked with setting up a wireless network in an office. The network will consist of 3 Access Points and a single switch. The network must meet the following parameters:

INSTRUCTIONS

Click on the devices to review their information and adjust the settings of the APs to meet the given requirements.

If any time you would like to bring back the initial state of the simulation, please click the Reset All button.

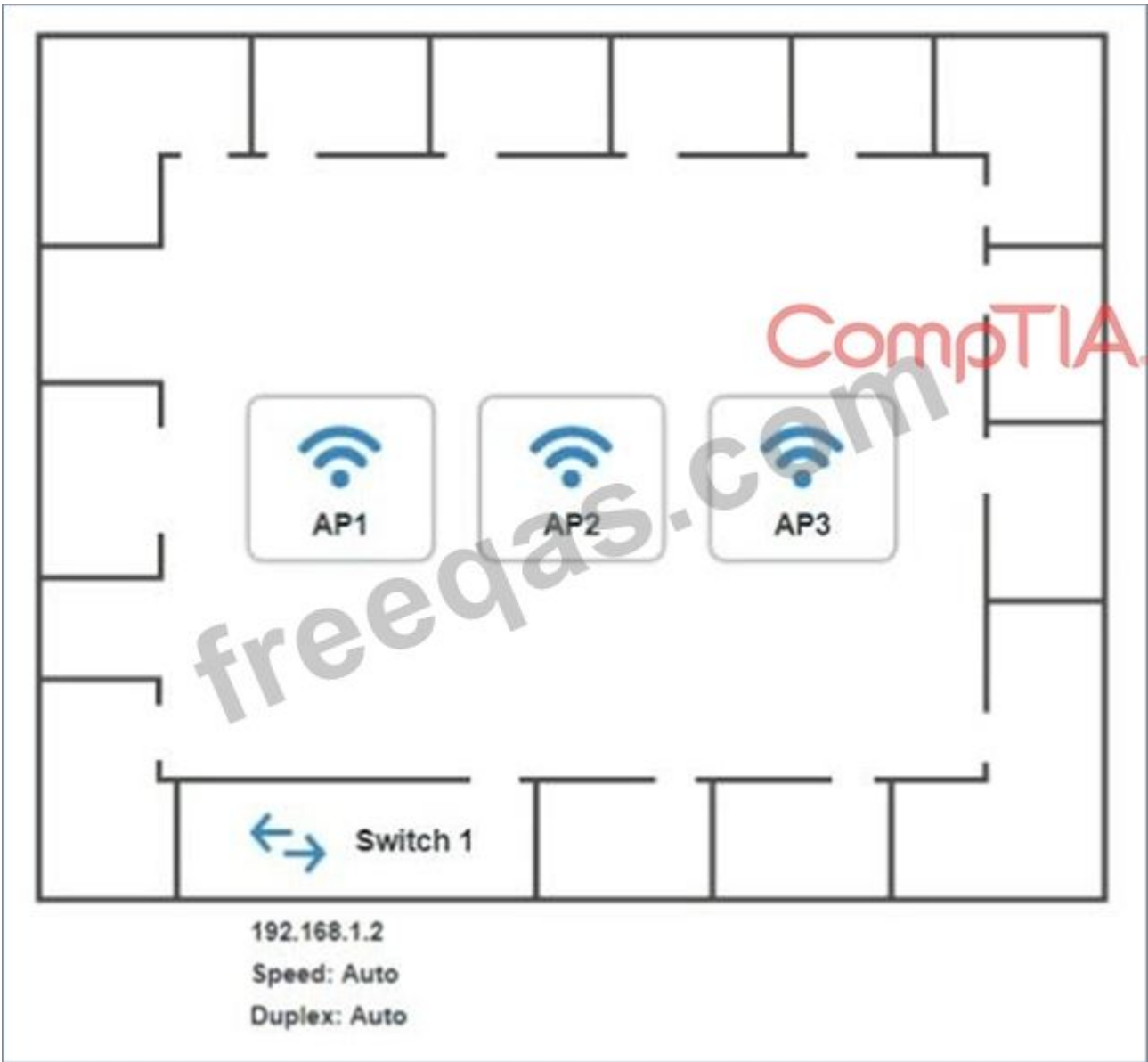

AP1 Configuration



https://ap1.setup.do

Basic Configuration

Access Point Name

AP1

IP Address

Gateway

192.168.1.1

SSID

SSID Broadcast

Yes No

Wireless

Mode

Channel

Wired

Speed

100 1000 Auto

Duplex

Auto Half Full

Cancel

Save

CompTIA

AP1 Configuration



https://ap1.setup.do

CompTIA

Basic Configuration

Access Point Name

AP1

IP Address

192.168.1.32

/ 27

Gateway

192.168.1.1

SSID

CorpNet

SSID Broadcast

Yes No

Wireless

Mode

Channel

Wired

Speed

100 1000 Auto

Duplex

Auto Half Full

Cancel

Save

AP1 Configuration

https://ap1.setup.do

Basic Configuration

1

2 Access Point Name AP1

3 IP Address 192.168.1.32 / 27

4

5 Gateway 192.168.1.1

6

7 SSID CorpNet

8 SSID Broadcast Yes No

9

Wireless

10

11

Mode

Channel

Wired

Speed 100 1000 Auto

Duplex Auto Half Full

Cancel Save

AP2 Configuration

https://ap2.setup.do

Basic Configuration

Access Point Name AP2

IP Address 192.168.1.64 / 27

Gateway 192.168.1.1

SSID CorpNet

SSID Broadcast Yes No

Wireless

Mode

Channel

Wired

Speed 100 1000 Auto

Duplex Auto Half Full

Cancel Save

AP2 Configuration



https://ap2.setup.do

Basic Configuration

Access Point Name	1	AP2
IP Address	2	192.168.1.64 / 27
Gateway	3	192.168.1.1
SSID	4	CorpNet
SSID Broadcast	5	<input type="radio"/> Yes <input checked="" type="radio"/> No

Wireless

Mode	6	
Channel	7	

Wired

Speed	<input checked="" type="radio"/> 100 <input type="radio"/> 1000 <input type="radio"/> Auto
Duplex	<input type="radio"/> Auto <input type="radio"/> Half <input checked="" type="radio"/> Full

Cancel

Save

AP3 Configuration

CompTIA

https://ap3.setup.do

Basic Configuration

Access Point Name: AP3

IP Address: /

Gateway: 192.168.1.1

SSID:

SSID Broadcast: Yes No

Wireless

Mode:

Channel:

Wired

Speed: 100 1000 Auto

Duplex: Auto Half Full

Cancel Save

AP3 Configuration

CompTIA

https://ap3.setup.do

Basic Configuration

Access Point Name: AP3

IP Address: 192.168.1.96 / 27

Gateway: 192.168.1.1

SSID: CorpNet

SSID Broadcast: Yes No

Wireless

Mode:

Channel:

Wired

Speed: 100 1000 Auto

Duplex: Auto Half Full

Cancel Save

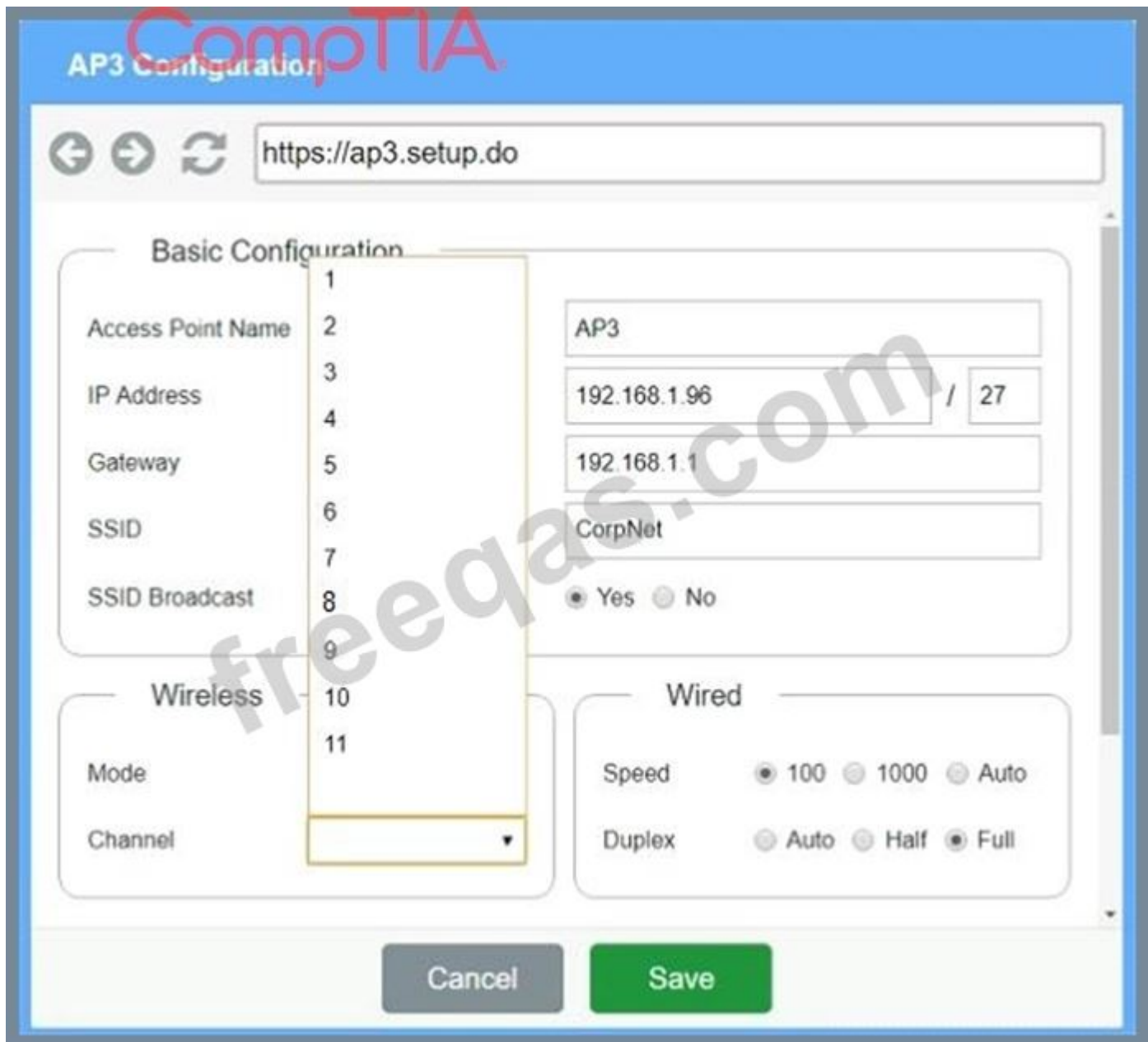

Answer:

On the first exhibit, the layout should be as follows

Access Point Name AP1

IP Address 192.168.1.3

Gateway 192.168.1.2

SSID corpnet

SSID Broadcast yes

Mode G

Channel 1

Speed Auto

Duplex Auto

WPA

Passphrase S3cr3t!

Exhibit 2 as follows

Access Point Name AP2

IP Address 192.168.1.4

Gateway 192.168.1.2

SSID corpnet

SSID Broadcast yes

Mode G

Channel 6

Speed Auto

Duplex Auto

WPA

Passphrase S3cr3t!

Exhibit 3 as follows

Access Point Name AP3

IP Address 192.168.1.5

Gateway 192.168.1.2

SSID corpnet

SSID Broadcast yes

Mode G

Channel 11

Speed Auto

Duplex Auto

WPA

Passphrase S3cr3t!

NEW QUESTION: 210

Which of the follow creates a secure remote connection at the OSI network layer?

A. SSL

B. DTLS

C. IPSec

D. L2TP

Answer: C ([LEAVE A REPLY](#))

NEW QUESTION: 211

You have been tasked with testing a CAT5e cable. A summary of the test results can be found on the screen.

Step 1: Select the tool that was used to create the cable test results.

Step 2: Interpret the test results and select the option that explains the results. After you are done with your analysis, click the 'Submit Cable Test Analysis' button.

Cable Crimp

Instructions: You have determined that the original crimp is faulty using the T568B cabling standard. Drag the appropriate tool to the RJ-45 Connector. When you are finished, click the Done button.

Question

You have been tasked with testing a CAT5e cable. A summary of the test results can be found on the screen.

Step 1: Select the tool that was used to create the cable test results.

Step 2: Interpret the test results and select the option that explains the results. After you are done with your analysis, click the 'Submit Cable Test Analysis' button.

Done Reset Hi

This window can be resized. ATA Simulatio



Reset Cable

CompTIA

Cable Test

Step 1: Select the tool that was used to create the cable test results.

Cable Test Result			
1, 2	Open	7ft	
3, 6	Short	7ft	
4, 5	Open	7ft	
7, 8	Open	7ft	

Tool Choices

- Crimper
- Cable Certifier
- Multimeter
- Punch Down Tool
- Protocol Analyzer
- OTDR
- Toner Probe

CompTIA

Answer:

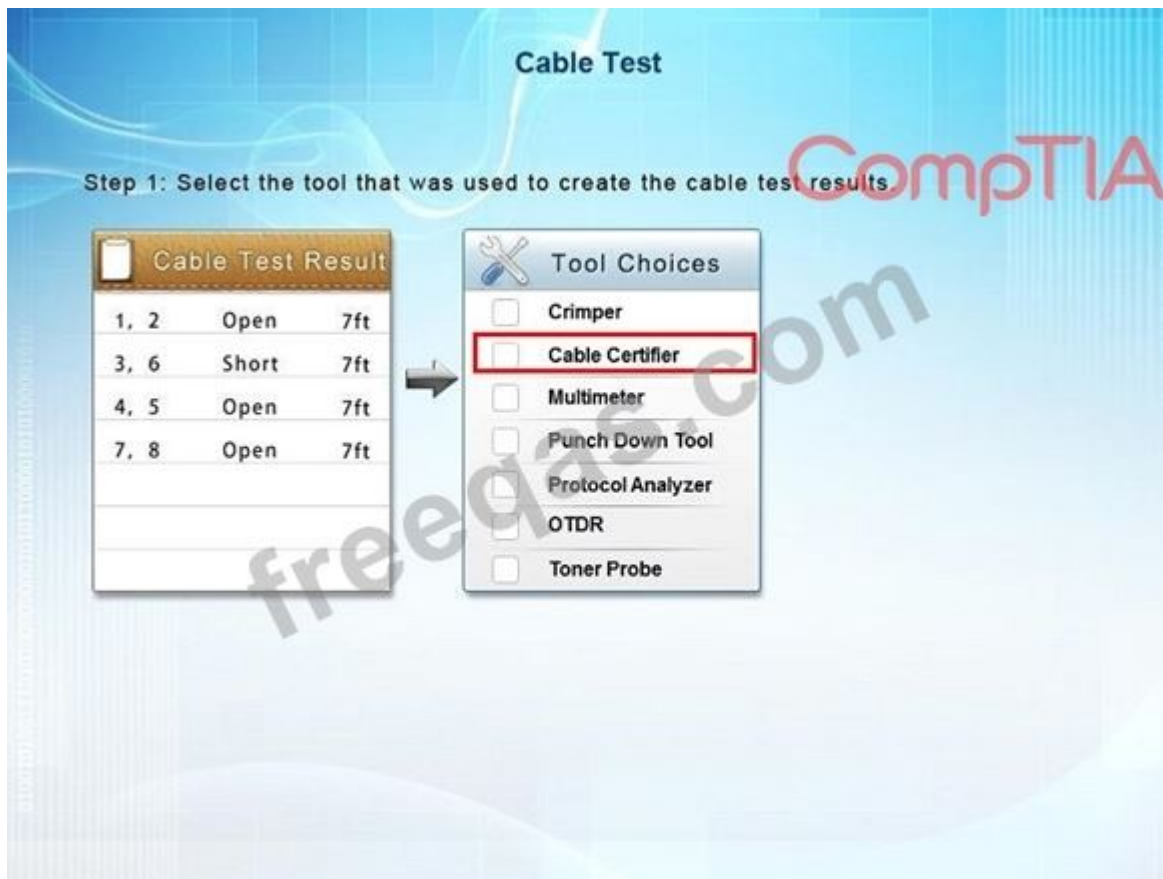

Explanation:

A Cable Certifier provides "Pass" or "Fail" information in accordance with industry standards but can also show detailed information when a "Fail" occurs. This includes shorts, the wire pairs involved and the distance to the short. When a short is identified, at the full length of the cable it means the cable has not been crimped correctly.

Valid N10-007 Dumps shared by PrepPdf.com for Helping Passing N10-007 Exam!
PrepPdf.com now offer the **newest N10-007 exam dumps**, the PrepPdf.com N10-007 exam **questions have been updated** and **answers have been corrected** get the **newest** PrepPdf.com N10-007 dumps with Test Engine here:
<https://www.preppdf.com/CompTIA/N10-007-prepaway-exam-dumps.html> (690 Q&As Dumps, **40%OFF Special Discount: Exam-Tests**)

NEW QUESTION: 212

A technician has started a major network project to upgrade to a higher throughput standard. The technician will need to install new patch panels and breakout boxes to support this infrastructure. Which of the following layers of the OSI model is the technician addressing at this stage of the upgrade?

- A. Physical
- B. Data link
- C. Network

D. Transport

Answer: ([SHOW ANSWER](#))

NEW QUESTION: 213

A company deploys many workers in the field who remotely access files from a server at headquarters.

Leadership is concerned about the risks posed when field workers update these files from unsecured networks.

Which of the following policy changes can the company make to MOST improve the confidentiality of connections when connecting remotely? (Choose two.)

- A. Configure IMAP over port 143 for email access on remote devices.
- B. Change file access protocols from SFTP to FTP on the remote devices.
- C. Configure WPA2 on the wireless networks at headquarters.
- D. Implement SSL VPN connections from the remote devices to headquarters.
- E. Utilize HTTPS to access the company intranet from remote devices.

Answer: D,E ([LEAVE A REPLY](#))

NEW QUESTION: 214

A network administrator discovered a rogue access point was sending a signal from inside the corporate headquarters. Which of the following would prevent the access point from providing access to the company's internal network?

- A. Disabling unnecessary services
- B. Configuring a geofence at the corporate boundary
- C. Enabling BPDU guard
- D. Placing unused ports in a separate VLAN

Answer: D ([LEAVE A REPLY](#))

NEW QUESTION: 215

An administrator is setting up a secure wireless network. The administrator decides to support 802.11n and

802.11g with a WPA2 pre-shared key. Users are given the SSID with the pre-shared key, but the administrator has disabled the SSID broadcast and MAC filtering. Some users have reported connection issues. Which of the following would MOST likely resolve the users' connection issues?

- A. Enable the SSID broadcast.
- B. Use a WEP 128-bit key.
- C. Limit the devices to 802.11n only.
- D. Enable MAC filtering.

Answer: ([SHOW ANSWER](#))

NEW QUESTION: 216

The Chief Executive Officer's (CEO's) tablet cannot connect to the wireless network from the corner office. A network technician verified the tablet can connect to the wireless network in other areas of the building. The distance between the office and the 802.11ac WAP is 150ft (46m), and there are a few cubicles in between.

Which of the following is the MOST likely cause of the tablet not connecting?

- A. Absorption
- B. Distance
- C. Reflection
- D. Attenuation
- E. Refraction

Answer: B ([LEAVE A REPLY](#))

NEW QUESTION: 217

After a server outage, a technician discovers that a physically damaged fiber cable appears to be the problem. After replacing the cable, the server will still not connect to the network. Upon inspecting the cable at the server end, the technician discovers light can be seen through one of the two fiber strands.

Which of the following should the technician do FIRST to reconnect the server to the network?

- A. Use a TDR to test both strands of a new replacement cable prior to connecting it to the server
- B. Replace the server's single-mode fiber cable with multimode fiber
- C. Move the fiber cable to different port on the switch where both strands function
- D. Reverse the fiber strands of the cable and reconnect them to the server

Answer: D ([LEAVE A REPLY](#))

NEW QUESTION: 218

A company has installed an access point and configured it to broadcast at 802.11n only. Some users are stating that they cannot connect to this access point. Which of the following is the MOST likely reason some users cannot connect?

- A. Incorrect channel
- B. Incompatible NICs
- C. Incorrect SSID
- D. Weak encryption

Answer: B ([LEAVE A REPLY](#))

NEW QUESTION: 219

Jeff, a technician, has been asked to add a subnet to the company's LAN. Which of the following interfaces on the router will be modified?

- A. FastEthernet 0/0
- B. Serial 0/0/0
- C. Console 0
- D. AUX 0

Answer: A ([LEAVE A REPLY](#))

NEW QUESTION: 220

A network administrator is concerned about the management traffic between a machine and the corporate router. Which of the following protocols should the administrator use to prevent a security breach?

- A. VNC
- B. SFTP
- C. SSH
- D. RDP

Answer: C ([LEAVE A REPLY](#))

NEW QUESTION: 221

A network technician has deployed an application that can remotely control desktops with different operating systems. The technician needs to be able to use a single client application for this control.

Which of the following has the technician utilized?

- A. VPN
- B. VNC
- C. RDP
- D. SSH

Answer: C ([LEAVE A REPLY](#))

NEW QUESTION: 222

A technician needs to verify an Ethernet run is functioning properly.

Which of the following tools should be used?

- A. Protocol analyzer
- B. Punch down tool
- C. Crimper
- D. Cable tester

Answer: D ([LEAVE A REPLY](#))

NEW QUESTION: 223

A network technician is upgrading a router's firmware. After downloading the file, the technician is instructed to run one of the commands below, obtain the output, and compare it with a value found on the vendor's website. The commands are as follows:

```
generate SHA1 value <name of the firmware>  
generate MD5 value <name of the firmware>
```

Which of the following procedures was the technician instructed to perform/

- A. Verify the file was decompressed.
- B. Verify the encryption algorithm of the file.
- C. Verify the was scanned against threats

D. Verify the integrity of the downloaded file.

Answer: D ([LEAVE A REPLY](#))

NEW QUESTION: 224

A company has a web-based application that is used by many different departments. The company has experienced some overload of resources on the database server. The network administrator implements a network device in between the servers and the database. Which of the following BEST describes the purpose of this device?

- A. Content filtering and network analysis
- B. Load balancing and providing high availability
- C. Port sniffing and protocol analysis
- D. Clustering and NIC teaming

Answer: B ([LEAVE A REPLY](#))

Explanation/Reference:

NEW QUESTION: 225

A network administrator is adding a new WAN circuit from the ISP to a new building. In which of the following locations would the network administrator find the utility entry point?

- A. DMZ
- B. Data tier
- C. Demarc
- D. IDF

Answer: C ([LEAVE A REPLY](#))

NEW QUESTION: 226

A network administrator is unable to identify the root cause of a network incident because insufficient evidence about the threat actor's actions was logged. The administrator notes that the server receiving and storing the events was not compromised by any attack and is properly communicating with all network devices.

Which of the following can the administrator employ to improve network access accountability?

- A. Configure SNMP on the network server.
- B. Collect traffic statistics from the servers using NetFlow data.
- C. Deploy a central SIEM server into the network.
- D. Activate the audit logs on the network server and resources.

Answer: C ([LEAVE A REPLY](#))

questions have been updated and answers have been corrected get the newest

PrepPdf.com N10-007 dumps with Test Engine here:

<https://www.preppdf.com/CompTIA/N10-007-prepaway-exam-dumps.html> (690 Q&As Dumps,

40%OFF Special Discount: Exam-Tests)

NEW QUESTION: 227

A company has just refreshed the hardware in its datacenter with new 10G Ethernet switches wishes to set up a new storage area network but must use existing infrastructure. Which of the following storage standards should the technician use?

- A. NAS
- B. InfinBand
- C. Fibre Channel
- D. iSCSI

Answer: A ([LEAVE A REPLY](#))

NEW QUESTION: 228

A technician is required to install a new DOCSIS-based Internet connection. Which of the following medium types does this use?

- A. Multimode
- B. Cat6a
- C. RG-6
- D. Single mode
- E. UTP

Answer: B ([LEAVE A REPLY](#))

NEW QUESTION: 229

A user is unable to connect to a server in another building. A technician is troubleshooting the issue and determines the following:

- 1) Client PC 1 has an IP address of 192.168.10.25/25
- 2) PC 1 can successfully ping its gateway of 192.168.10.1/25 which is an interface of router A
- 3) Server A is named 'BLDGBFILESVR01' and has an IP address of 192.168.10.145/25
- 4) PC 2 with an IP address of 192.168.10.200/25 can successfully ping server A However, when PC 1 pings server A, it receives a destination host unreachable response. Which of the following is the MOST likely cause?

- A. Link from PC 1 to router A has duplex issues
- B. Link from server A to PC 2 is down
- C. Link from router A to server A is down
- D. Link from router A to PC 1 are on different subnets

Answer: D ([LEAVE A REPLY](#))

NEW QUESTION: 230

A network technician has finished configuring a new DHCP for a network. To ensure proper functionality, which of the following ports should be allowed on the server's local firewall? (Choose two.)

- A. 389
- B. 68
- C. 53
- D. 67
- E. 21
- F. 20

Answer: B,D ([LEAVE A REPLY](#))

NEW QUESTION: 231

A utility company has installed a wireless device at a residence that allows the company to view power consumption online. The resident reports the 802.11ac home wireless intermittently loses connectivity for about 15 minutes twice a day.

Which of the following is the MOST likely cause?

- A. There is interference with the smart reader.
- B. An IoT device is causing a DoS attack on the wireless network.
- C. There is additional data being transferred over the wireless network.
- D. The utility company throttles power during peak hours.

Answer: ([SHOW ANSWER](#))

NEW QUESTION: 232

Users have been experiencing connection timeout issues when using a web-based program. The network technician determines the problem happened due to a TTL setting that was set too low on the firewall. Which of the following BEST enabled the network technician to reach this conclusion?

- A. Reviewing application logs
- B. Reviewing a baseline report
- C. Reviewing SLA requirements
- D. Reviewing a vulnerability scan

Answer: ([SHOW ANSWER](#))

NEW QUESTION: 233

A network manager is reviewing recent changes after learning the network health metrics are no longer being recorded. The manager discovers the ACL has been updated to the following:

```
1. deny tcp any any eq 123
2. deny tcp any any eq 3389
3. deny tcp any any eq 161
4. deny tcp any any eq 5060
5. permit tcp any any
```

Which of the following lines in the ACL points to the issue?

- A. Line 5
- B. Line 3
- C. Line 1
- D. Line 2
- E. Line 4

Answer: C ([LEAVE A REPLY](#))

NEW QUESTION: 234

A network technician is designing a network cable upgrade in a newly acquired office space. The IT manager wants to install a standardized twisted pair cable solution that supports speeds up to 1 Gbps and terminates with a standard RJ45 connector. Which of the following cable types should the technician suggest?

- A. RG-6
- B. Cat 5
- C. Cat 6
- D. Cat 3
- E. SMF

Answer: C ([LEAVE A REPLY](#))

NEW QUESTION: 235

A user has called the help desk with a problem reaching certain servers within the organization. The organization is using RFC 1819 for internal networks. The servers having trouble are configured with the following IP addresses: 192.130.135.5 and 192.130.135.6. The user cannot connect to the correct servers.

Which of the following explain why this is happening to the user?

- A. The servers are periodical/ going offline and rejecting the connection.
- B. The default route in the user's computer points to the wrong upstream device.
- C. The network has been configured with an inappropriate scheme
- D. The IPS system is flagging the traffic as suspicious and terminating the connection.

Answer: C ([LEAVE A REPLY](#))

NEW QUESTION: 236

The Chief Executive Officer's (CEO's) tablet cannot connect to the wireless network from the corner office. A network technician verified the tablet can connect to the wireless network in other areas of the building. The distance between the office and the 802.11ac WAP is 150ft (46m), and there are a few cubicles in between. Which of the following is the MOST likely cause of the tablet not connecting?

- A. Absorption
- B. Distance
- C. Reflection
- D. Refraction

E. Attenuation

Answer: B ([LEAVE A REPLY](#))

NEW QUESTION: 237

Which of the following backup techniques is used to capture all the data that has changed since the last full backup?

- A. Incremental
- B. Snapshot
- C. Differential
- D. Replica

Answer: C ([LEAVE A REPLY](#))

NEW QUESTION: 238

Employees want the ability to use personal devices on the guest network while working out at the company gym. In order to meet the request, which of the following policies requires employee adherence?

- A. MOU
- B. AUP
- C. SLA
- D. NDA

Answer: B ([LEAVE A REPLY](#))

NEW QUESTION: 239

A company would like all HTTP traffic to filter through a proxy server on port 8080. Which of the following port numbers needs to be redirected through the proxy server to accomplish this?

- A. 143
- B. 443
- C. 80
- D. 20

Answer: C ([LEAVE A REPLY](#))

NEW QUESTION: 240

Workstations are unable to access the Internet after a recent power outage. Configure the appropriate devices to ensure ALL workstations have Internet connectivity.

Instructions: All ports can be enabled (green) or disabled (red). When you have completed the simulation please select the Done button.

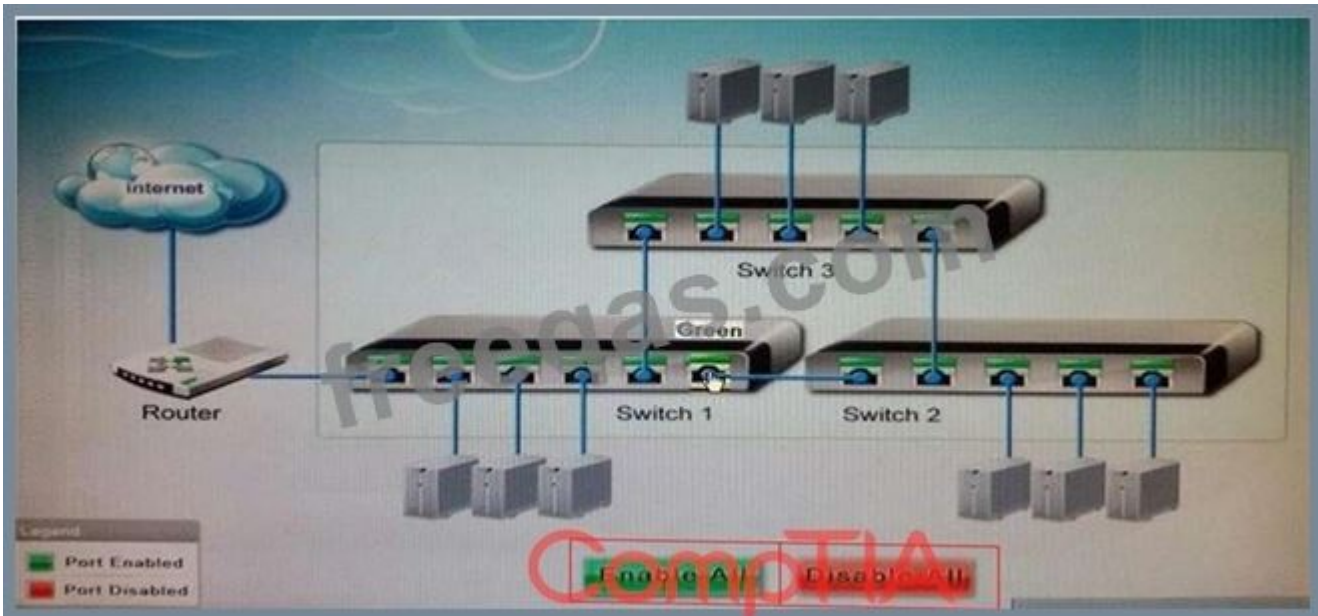

Answer:

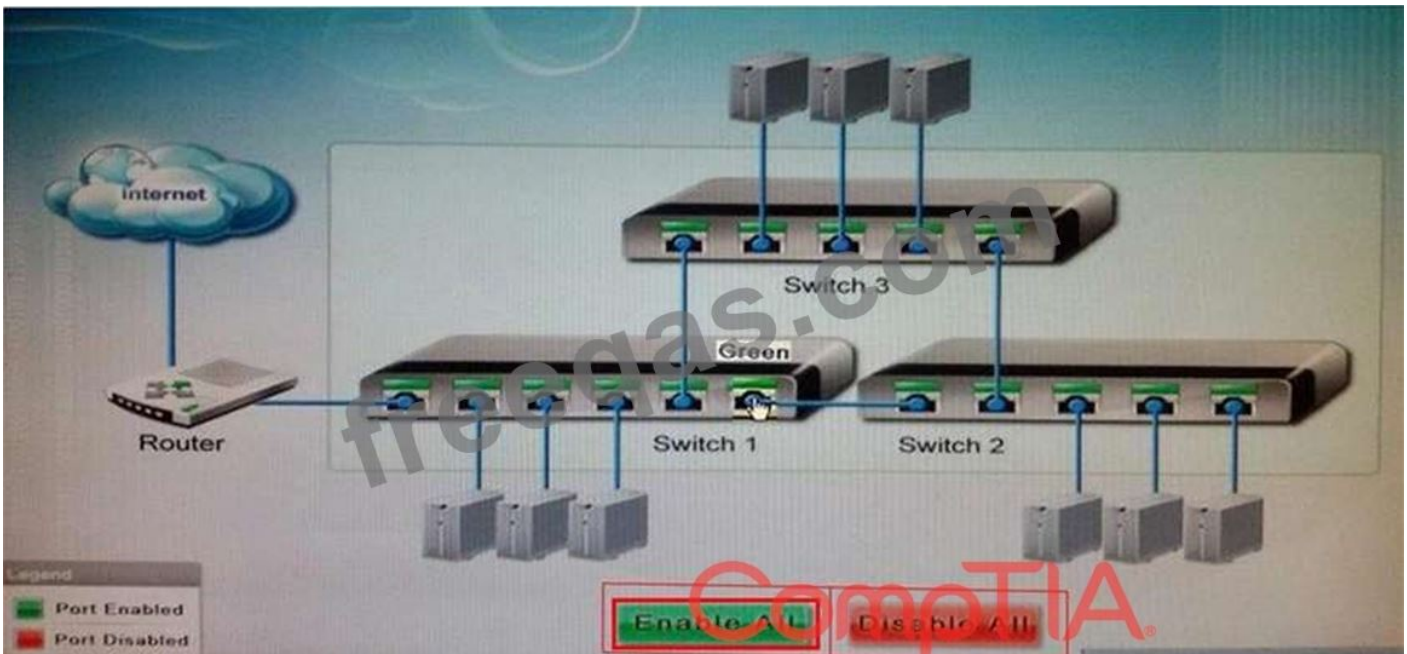

NEW QUESTION: 241

Ann, a new employee within a department, cannot print to any of the printers in the department or access any of the resources that others can. However, she can access the Internet. The network engineer has confirmed that Ann's account has been set up the same as the others. There are no access lists restricting Ann's access.

Which of the following could be the issue for this lack of access?

- A. VLAN mismatch
- B. Spanning tree blocked ports
- C. Duplex/speed mismatch
- D. DHCP server issue
- E. DNS server issue

Answer: (SHOW ANSWER)

Valid N10-007 Dumps shared by PrepPdf.com for Helping Passing N10-007 Exam!
PrepPdf.com now offer the **newest N10-007 exam dumps**, the PrepPdf.com N10-007 exam **questions have been updated** and **answers have been corrected** get the **newest** PrepPdf.com N10-007 dumps with Test Engine here:
<https://www.preppdf.com/CompTIA/N10-007-prepaway-exam-dumps.html> (690 Q&As Dumps, **40%OFF Special Discount: Exam-Tests**)

NEW QUESTION: 242

Which of the following communication media can carry many voice, data, and video channels simultaneously over multiple frequencies?

- A. CSMA
- B. Analog modem
- C. Broadband
- D. Baseband

Answer: C (LEAVE A REPLY)

NEW QUESTION: 243

A company is allowing its employees to use their personal computers, tablets, and IoT devices while at work. However, there are rules and guidelines to which employees must adhere. Which of the following documents applies to these employees?

- A. SLA
- B. BYOD
- C. NDA
- D. SOP

Answer: B (LEAVE A REPLY)

NEW QUESTION: 244

A technician is observing brownout issue at a smaller office. At least once a week, the edge switch power cycles. Which of the following should the technician do to resolve the issue?

- A. Install a UPS.
- B. Install a new switch.
- C. Install a new electrical circuit.
- D. Replace the switch uplink cable.

Answer: B (LEAVE A REPLY)

An administrator needs to connect to a server to install security patches. The administrator requests that port

NEW QUESTION: 245

3389 be allowed through the firewall. Which of the following access methods is the administrator

looking to use?

- A. Telnet
- B. SFTP
- C. RDP
- D. SSH

Answer: C ([LEAVE A REPLY](#))

NEW QUESTION: 246

Keeping an authoritative and timely record of network devices and their settings is a key activity of which of the following?

- A. Bandwidth shaping
- B. Quality of service
- C. Project management
- D. Configuration management

Answer: D ([LEAVE A REPLY](#))

NEW QUESTION: 247

A network technician is troubleshooting a connectivity issue with Joe, a user. Joe has reported that when he attempts to RDP to machine1 (192.168.21.21) by name, he is connected to machine3 (192.168.21.23). When the network technician runs the command `nslookup machine1`, it returns the IP address 192.168.21.23; but when the ping an 192.168.21.23 command is run, the results return the hostname machine3. Which of the following DNS records should be updated to allow RDP connections to machine1 by hostname?

- A. TXT
- B. A
- C. SRV
- D. PTR

Answer: B ([LEAVE A REPLY](#))

NEW QUESTION: 248

You have been tasked with testing a CAT5e cable. A summary of the test results can be found on the screen.

Instructions

Step 1: Select the tool that was used to create the cable test results.

Step 2: Interpret the test results and select the option that explains the results. After you are done with your analysis, click the 'Submit' button.

If at any time you would like to bring back the initial state of the simulation, please click the Reset All button.

Answer Area **CompTIA**

Step 1 Select the tool that was used to create the cable test results

▼

- Cable Certifier
- Punch Down Tool
- Crimper
- Toner Probe
- OTDR
- Multimeter
- Protocol Analyzer

Step 2 Interpret the test results and select the option that explains the results

▼

- Correctly crimped cable
- Incorrectly crimped cable

Answer:

Answer Area

Step 1 Select the tool that was used to create the cable test results

Step 2 Interpret the test results and select the option that explains the results

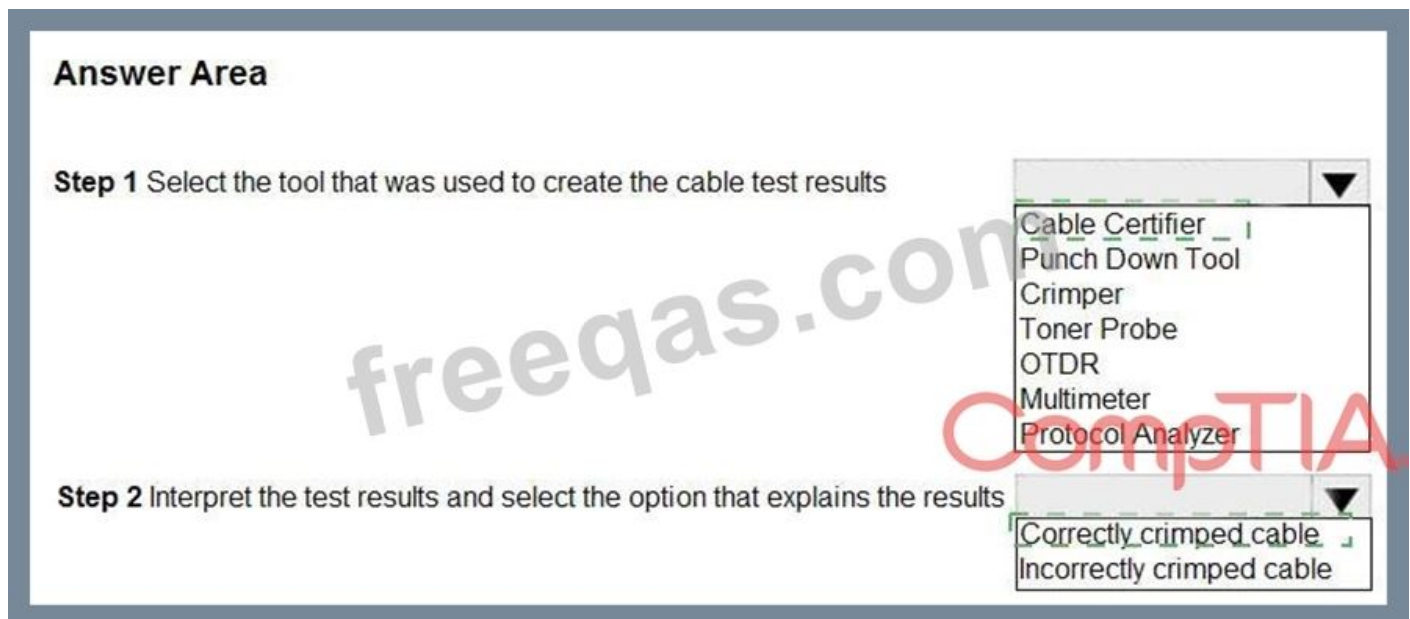

The screenshot shows the answer area with the following selections:

- Step 1: Cable Certifier
- Step 2: Correctly crimped cable

Explanation

Step 1 - Cable certifier

Step 2 - correctly crimped cable

NEW QUESTION: 249

In which of the following layers of the OSI model is checksum added to the end of an Ethernet frame?

- A. Layer 2
- B. Layer 3
- C. Layer 5
- D. Layer 4

Answer: A ([LEAVE A REPLY](#))

NEW QUESTION: 250

Which of the following should be configured on the network to achieve performance for the FCoE storage traffic?

- A. PoE

- B. DHCP snooping
- C. Jumbo frames
- D. Virtual IP

Answer: C ([LEAVE A REPLY](#))

Explanation/Reference:

NEW QUESTION: 251

Ann, a network technician, has relocated a rack that contains the networking and server equipment from the third floor to the sixth floor. To connect the rack-mounted router to the media converter in the first-floor MDF, she extended the length of the original 197ft (60m) Cat5e cable to 395ft (120m) by attaching another 197ft (60m) cable with an RJ45 coupler. After the move, users report intermittent connectivity to external websites, although connectivity to internal hosts has not changed. Which of the following is a network performance issue that is MOST likely causing this issue?

- A. Transceiver mismatch
- B. Attenuation
- C. Jitter
- D. Crosstalk

Answer: ([SHOW ANSWER](#))

NEW QUESTION: 252

Which of the following functions would be used to securely monitor and actively manage external connections?

- A. Packet shaper
- B. HIDS
- C. VPN concentrator
- D. Load balancer

Answer: C ([LEAVE A REPLY](#))

NEW QUESTION: 253

A new user is reporting connectivity issues. Zach, the network technician, notices that there is no link light on the user's NIC. Which of the following would be used to verify the wiring back to the patch panel?

- A. Toner probe
- B. Butt set
- C. Cable certifier
- D. Snips

Answer: ([SHOW ANSWER](#))

NEW QUESTION: 254

A network administrator configures an email server to use secure protocols. When the upgrade is

completed, which of the following ports on the firewall should be configured to allow for connectivity? (Choose three.)

- A. TCP 993
- B. TCP 25
- C. TCP 110
- D. TCP 587
- E. TCP 389
- F. TCP 995
- G. TCP 143

Answer: A,D,F ([LEAVE A REPLY](#))

NEW QUESTION: 255

A network technician is working on a new wireless project. The network manager has a primary requirement of achieving speeds of at least 1 Gbps when connected. Which of the following standards would be appropriate for the technician to implement?

- A. 802.11ac
- B. 802.11n
- C. 802.11b
- D. 802.11a

Answer: D ([LEAVE A REPLY](#))

NEW QUESTION: 256

Which of the following allows a technician to gather information about the operating system?

- A. Fingerprinting
- B. Domain services
- C. Reconnaissance
- D. Countermeasures

Answer: ([SHOW ANSWER](#))

Valid N10-007 Dumps shared by PrepPdf.com for Helping Passing N10-007 Exam!
PrepPdf.com now offer the **newest N10-007 exam dumps**, the PrepPdf.com N10-007 exam **questions have been updated** and **answers have been corrected** get the **newest** PrepPdf.com N10-007 dumps with Test Engine here:
<https://www.preppdf.com/CompTIA/N10-007-prepaway-exam-dumps.html> (**690** Q&As Dumps,
40%OFF Special Discount: **Exam-Tests**)

NEW QUESTION: 257

A network technician is installing a new lab network for systems engineers to test patches and updates in a simulated production environment. The engineers have requested that the lab

network have unrestricted access to the Internet, but they want to limit connectivity from the LAN to the systems engineers only. Which of the following will the technician MOST likely implement to meet these requirements?

- A. A switch
- B. A firewall
- C. A proxy server
- D. A bridge

Answer: B (LEAVE A REPLY)

NEW QUESTION: 258

Multiple users are reporting that they are unable to access the network. The ENTIRE network is shown in the diagram. PCs are not statically assigned IP addresses. The following devices will display settings:

- * WorkstationA
- * WorkstationB
- * WorkstationC
- * WorkstationD
- * WorkstationE
- * WorkstationF
- * WorkstationG
- * Laptop1
- * Laptop2
- * DHCP server1
- * DHCP server2

Review the settings and select the box in the diagram that identifies the device causing the issue. Only one device can be selected at a time.

After checking the device that is causing the issue, select the second tab in the lower left hand corner. Identify the reason as to why some users are unable to access the network.

Instructions:

When the simulation is complete, select the Done button to submit.

Part 1

Site A and B Network Diagram

Instructions: Only one device can be selected at a time. Please ensure you complete Part 1 and Part 2 of the simulation.

SITE A



SITE B



WORKSTATION A

IP Address	172.30.0.10
Netmask	255.255.255.0
Gateway	172.30.0.1

OK

WORKSTATION B

IP Address	172.30.0.14
Netmask	255.255.255.0
Gateway	172.30.10.1

OK

WORKSTATION C

IP Address	169.254.200.67
Netmask	255.255.255.0
Gateway	

OK

WORKSTATION D

IP Address	172.16.0.221
Netmask	255.255.255.0
Gateway	172.16.0.1

OK

WORKSTATION E

IP Address	172.16.0.21
Netmask	255.255.255.0
Gateway	172.16.0.1

OK

WORKSTATION F

IP Address	172.16.10.43
Netmask	255.255.255.0
Gateway	172.16.10.1

OK

WORKSTATION G

IP Address	172.16.10.120
Netmask	255.255.255.0
Gateway	172.16.10.1

OK

LAPTOP 1

IP Address	172.16.0.220
Netmask	255.255.255.0
Gateway	172.16.0.1

OK

LAPTOP 2

IP Address	172.30.0.12
Netmask	255.255.255.0
Gateway	172.30.0.1

OK

DHCP SERVER 1

IP Address	172.30.0.5
Netmask	255.255.255.0
Gateway	172.30.0.1

DHCP Scope	172.30.0.10-250
Gateway	172.30.0.1
DNS Servers	10.200.2.20, 10.200.3.20
DHCP Lease Time	8 days

OK

DHCP SERVER 2

IP Address	172.30.0.5
Netmask	255.255.255.0
Gateway	172.16.0.1

DHCP Scope	172.16.0.10-250
Gateway	172.16.0.1
DNS Servers	10.200.2.20, 10.200.3.20
DHCP Lease Time	8 days

OK

Part 2

Identify the reason as to why some users are unable to access the network.

- A. WAN and LAN ports are reversed on the router.
- B. Workstation(s) are plugged into switch ports configured with half duplex.
- C. DHCP server scope is full and is not providing IP addresses.
- D. STP has disabled some of the ports on the switch.
- E. The NIC driver is not installed.
- F. A wireless client is unable to associate to the AP.
- G. The site-to-site router was configured with the incorrect ACL.

Answer: F ([LEAVE A REPLY](#))

NEW QUESTION: 259

An administrator wants to implement an additional authentication factor to the remote SSH servers. Which of the following accomplishes this goal with the principle of *something you have*?

- A. Certificate
- B. pattern
- C. Password
- D. Fingerprint

Answer: D ([LEAVE A REPLY](#))

Explanation

Something you know is a user name, a password, a passphrase, or a personal identification number (PIN).

Something you have, like a key fob you scan to get into your gym at night. Something you are indicates some distinguishing, unique characteristic, like the biometrics just mentioned.

NEW QUESTION: 260

The Chief Information Officer (CIO) has noticed the corporate wireless signal is available in the parking lot. Management requests that the wireless network be changed so it is no longer accessible in public areas, without affecting the availability inside the building. Which of the following should be changed on the network?

- A. Channel overlap
- B. Distance limitations
- C. Power levels
- D. Overcapacity

Answer: ([SHOW ANSWER](#))

NEW QUESTION: 261

Management is concerned there is excessive traffic on the network. A network technician wants to run a quick port scan to see any systems that have open ports. Which of the following tools should be used to do this?

- A. tcpdump
- B. dig
- C. nmap
- D. netstat

Answer: C ([LEAVE A REPLY](#))

Explanation

NEW QUESTION: 262

During a weekend event, several people reported they were unable to get onto the wireless network. On Monday, the technician could not find a problem. Which of the following is the MOST

likely cause?

- A. Overcapacity
- B. Crosstalk
- C. Wrong passphrase
- D. Channel overlap

Answer: ([SHOW ANSWER](#))

NEW QUESTION: 263

Which of the following WAN transmission mediums is typically used in geographically remote locations?

- A. Copper
- B. Satellite
- C. Wireless
- D. Fiber

Answer: B ([LEAVE A REPLY](#))

NEW QUESTION: 264

Devices on a network will need to obtain DHCP leases from a server on a different network. Which of the following must the engineer implement for DHCP to forward requests to the designated server?

- A. An IP helper
- B. A proxy server
- C. A forward lookup zone
- D. Trunking

Answer: D ([LEAVE A REPLY](#))

NEW QUESTION: 265

A network technician needs to separate a web server listening on port 80 from the internal LAN and secure the server from the public Internet. The web server should be accessible to the public Internet over port 80 but not the private LAN. Currently, the network is segmented with a network-based firewall using the following IP addressing scheme on each interface:

Zone	Interface	IP Address
Public	eth0	10.0.0.1/24
DMZ	eth1	10.0.1.1/24
Private	eth2	10.0.2.1/24

Which of the following ones should the technician use to place the web server and which of the following firewall rules should the technician configure?

- A. Place the web server in the DMZ with an inbound rule from eth0 interface to eth1 to accept traffic over port 80 designated to the web server

B. Place the web server in the public zone with an inbound rule from eth0 interface to accept traffic over port 80 designated to the web server

C. Place the web server in the private zone with an inbound rule from eth2 interface to eth1 to accept traffic over port 80 designated to the web server

D. Place the web server in the DMZ with an inbound rule from eth1 interface to eth0 to accept traffic over port 80 designated to the web server

Answer: A ([LEAVE A REPLY](#))

NEW QUESTION: 266

You are tasked with creating a network that will accomplish the following requirements

Requirements:

- 1) The remote sales team must be able to connect to the corporate network
- 2) Each department must have ONLY two PCs and a server
- 3) Each department must be segmented from each other
- 4) The following VLANs have been designated:
 - a) VLAN 2- Finance
 - b) VLAN 12- Sales
 - c) VLAN 22- Human Resources (HR)

Complete the network by dragging the required objects into the diagram

INSTRUCTIONS: Objects can be used multiple times and not all placeholders need to be filled

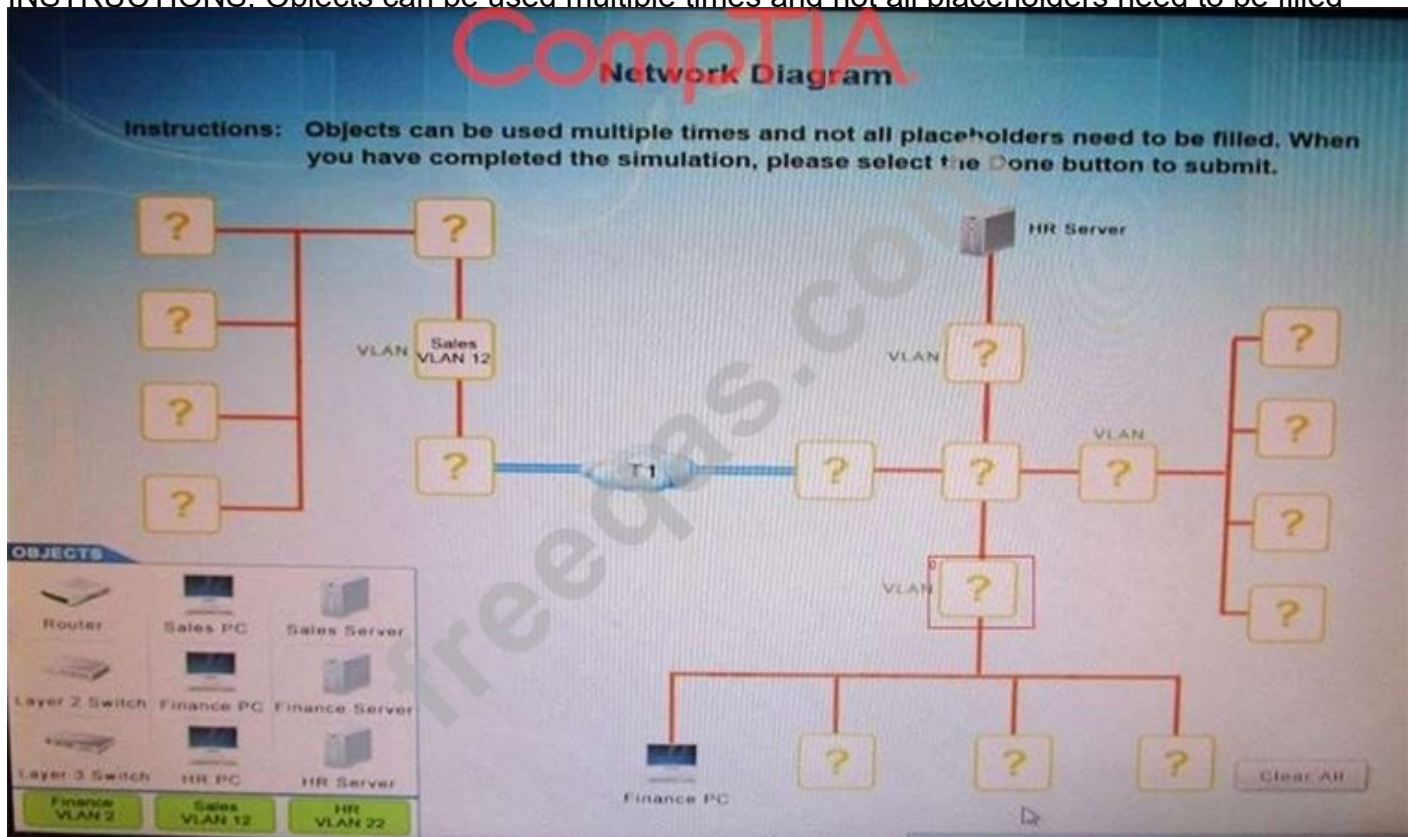

Answer:

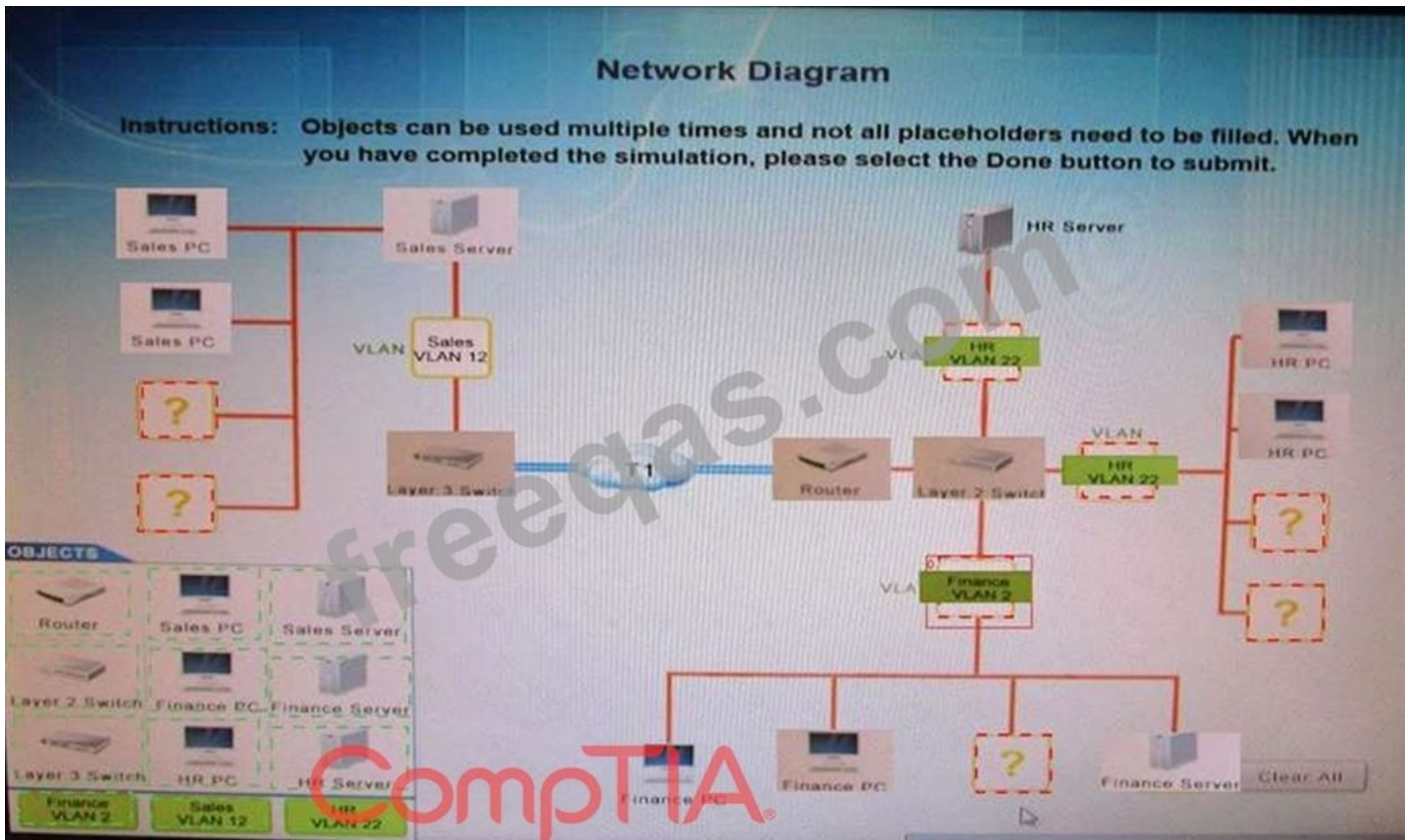

Explanation

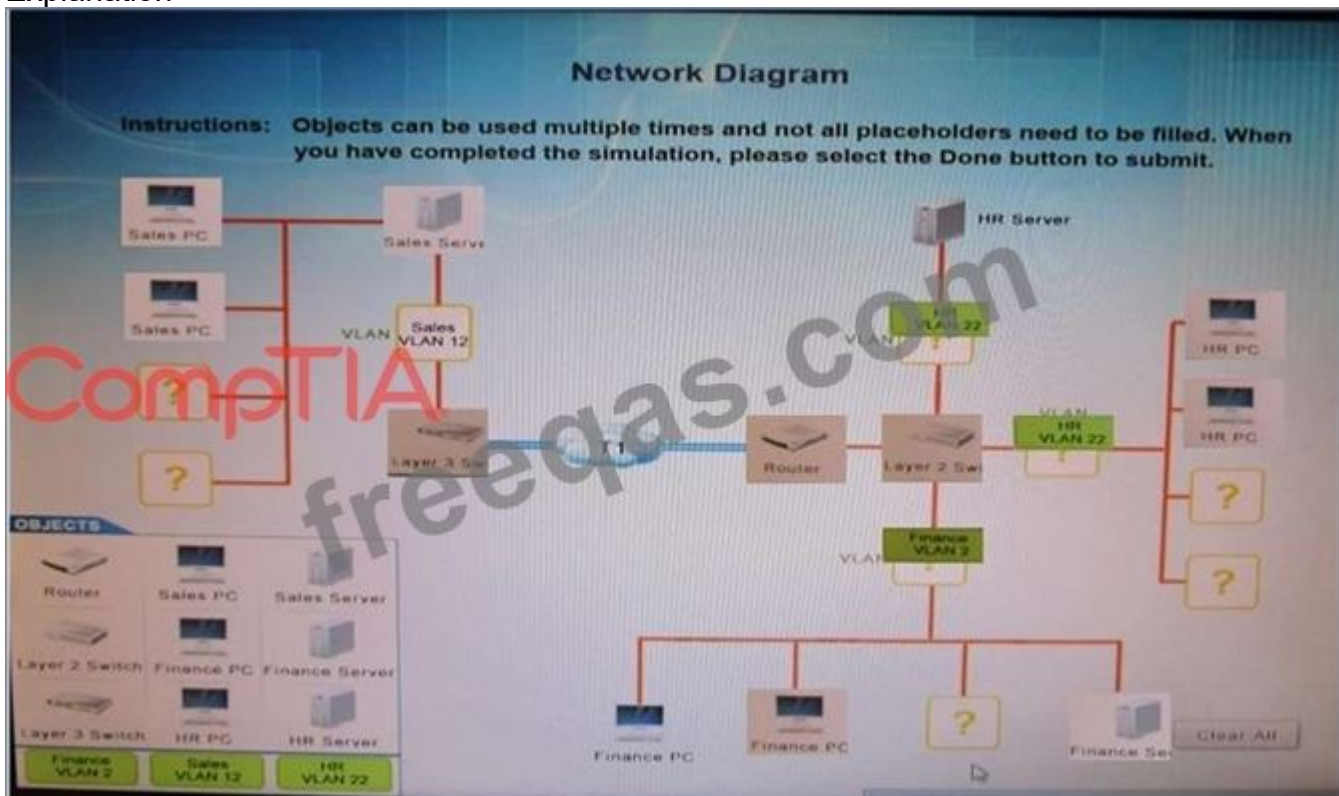

NEW QUESTION: 267

Lab Simulation

You have been tasked with setting up a wireless network in an office. The network will consist of 3 access points and a single switch. The network must meet the following parameters.

- The SSIDs need to be configured as corpnet with a key of S3cr3t!

- The wireless signals should not interfere with each other
- The subnet the Access points and Switch are on should only support 30 devices maximum
- The access Points should be configured to only support TKIP clients at a maximum speed

Instructions: Click on the devices to review their information and adjust the setting of the APs to meet the given requirements.

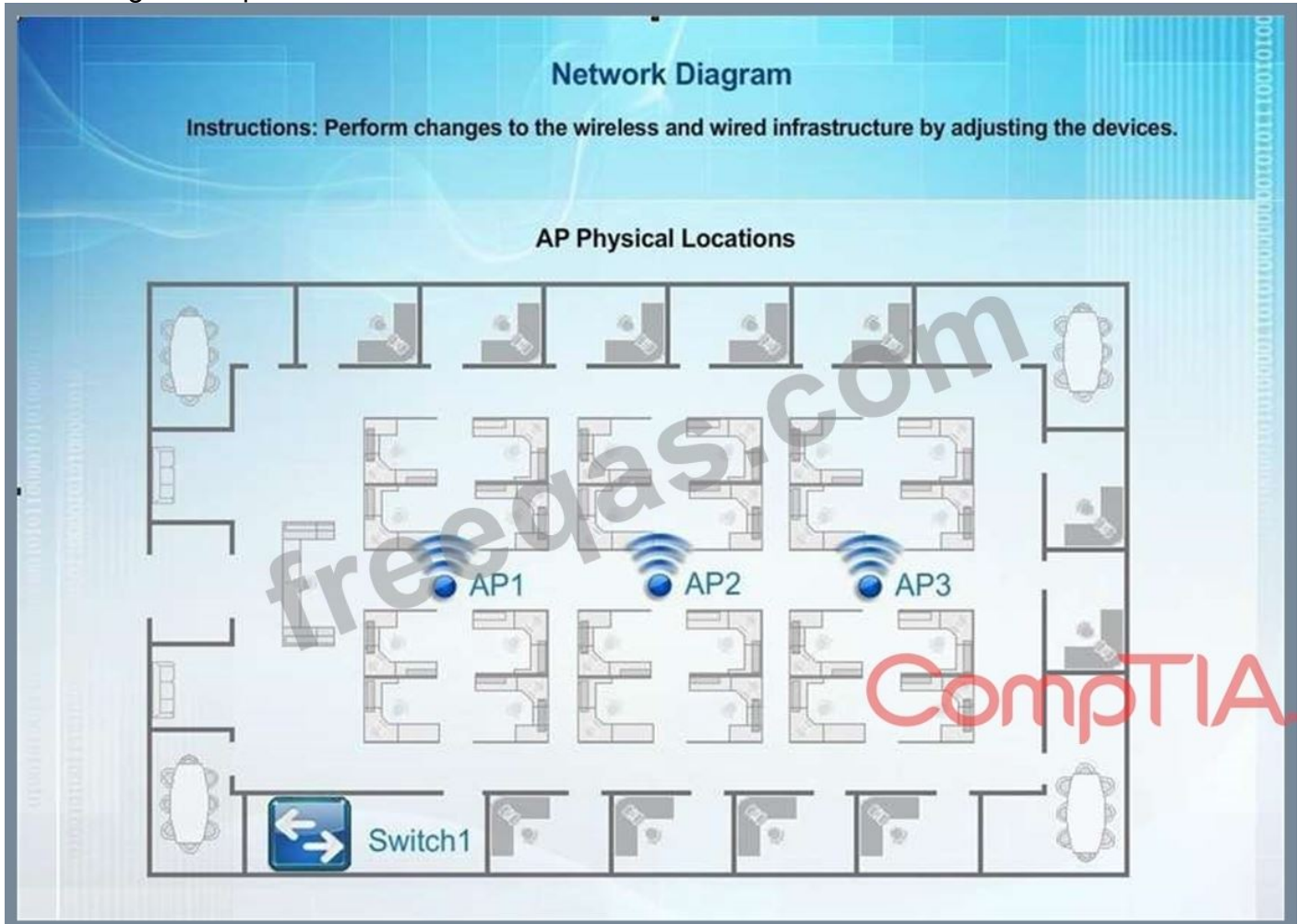

Answer:

This simulation is still under construction. On the first exhibit, the layout should be as follows

Access Point Name AP1 IP Address 192.168.1.3 Gateway 192.168.1.2 SSID corpnet SSID Broadcast yes Mode G Channel 1 Speed Auto Duplex Auto WPA Passphrase S3cr3t!

Exhibit 2 as follows

Access Point Name AP2

IP Address 192.168.1.4

Gateway 192.168.1.2

SSID corpnet

SSID Broadcast yes

Mode G

Channel 6

Speed Auto

Duplex Auto

WPA

Passphrase S3cr3t!

Exhibit 3 as follows

Access Point Name AP3

IP Address 192.168.1.5

Gateway 192.168.1.2

SSID corpnet

SSID Broadcast yes

Mode G

Channel 11

Speed Auto

Duplex Auto

WPA

Passphrase S3cr3t!

NEW QUESTION: 268

The security manager reports that individual systems involved in policy or security violations or incidents cannot be located quickly. The security manager notices the hostnames all appear to be randomly generated characters. Which of the following would BEST assist the security manager identifying systems involved in security incidents?

- A. Enforce port security to require system authentication
- B. Implement a standardized UNC
- C. Label existing systems with current hostnames
- D. Forward the DHCP logs to the security manager every day

Answer: B (LEAVE A REPLY)

Explanation/Reference:

NEW QUESTION: 269

A network technician has been asked to create secure private networks between a company's headquarters and several branch locations. The company has provided the on-premises equipment, but each branch has a different ISP. Which of the following technologies should the technician consider using to accomplish this?

- A. Site-to-site
- B. Client-to-site
- C. Point-to-point
- D. Point-to-multipoint

Answer: A (LEAVE A REPLY)

Explanation/Reference:

NEW QUESTION: 270

A wireless technician needs to deploy a single 802.11 standard that supports both 2.4GHz and

5GHz frequencies with up to 40MHz channel widths. Which of the following wireless standards should the technician configure?

- A. b
- B. ac
- C. n
- D. g

Answer: ([SHOW ANSWER](#))

NEW QUESTION: 271

A technician is setting up a surveillance system at a small office. The customer would like to have the network controlled by the office's firewall/router device. The office has a coaxial ISP connection with an ISP provided cable modem. Which of the following should the technician configure on the cable modem to meet the customer requirements?

- A. PPPoE
- B. Bridge mode
- C. PPP
- D. Route with NAT

Answer: D ([LEAVE A REPLY](#))

Valid N10-007 Dumps shared by PrepPdf.com for Helping Passing N10-007 Exam!
PrepPdf.com now offer the **newest N10-007 exam dumps**, the PrepPdf.com N10-007 exam **questions have been updated** and **answers have been corrected** get the **newest** PrepPdf.com N10-007 dumps with Test Engine here:
<https://www.preppdf.com/CompTIA/N10-007-prepaway-exam-dumps.html> (**690** Q&As Dumps, **40%OFF** Special Discount: **Exam-Tests**)

NEW QUESTION: 272

An administrator recently implemented new SOHO routers for a company's teleworking employees. Before deploying the routers, the administrator changed the default credentials and disabled unnecessary services.

Within a few days of deployment, hackers gained access to the routers. Which of the following is the MOST important thing the administrator forgot to do?

- A. Create a database of file hashes on the router.
- B. Disable unused physical router ports.
- C. Generate new encryption keys.
- D. Upgrade the router firmware.

Answer: B ([LEAVE A REPLY](#))

NEW QUESTION: 273

A Content filter is set to analyze XML and JSON that users access from the internet. At which of the following layer's is this analysis taking place?

- A. 7
- B. 1
- C. 3
- D. 5

Answer: C ([LEAVE A REPLY](#))

NEW QUESTION: 274

A network technician is setting up a new web server on the company network. One of the requirements for the web server is to ensure the end users can securely authenticate to the application to perform their job duties.

Which of the following ports should the network technician request from the firewall team to comply with this requirement?

- A. 389
- B. 69
- C. 22
- D. 443
- E. 80

Answer: D ([LEAVE A REPLY](#))

NEW QUESTION: 275

Multiple users are reporting that they are unable to access the network. The ENTIRE network is shown in the diagram. PCs are not statically assigned IP addresses. The following devices will display settings.

- * WorkstationA
- * WorkstationB
- * WofkstationC
- * WorkstationD
- * WokstationE
- * WorkstalionF
- * WorkstalionG
- * Laptop1
- * Laptop2
- * DHCP server1
- * DHCP serverr2

Review the settings and select the box in the diagram that identifies the device causing the issue. Only one device can be selected at a time.

After checking the device that is causing the issue, select the second tab in the lower left hand corner. Identify the reason as to why some users are unable to access the network.

SITE A and B Network Diagram

Instructions: Only one device can be selected at a time. Please ensure you complete Part 1 and Part 2 of the simulation.

SITE A



SITE B

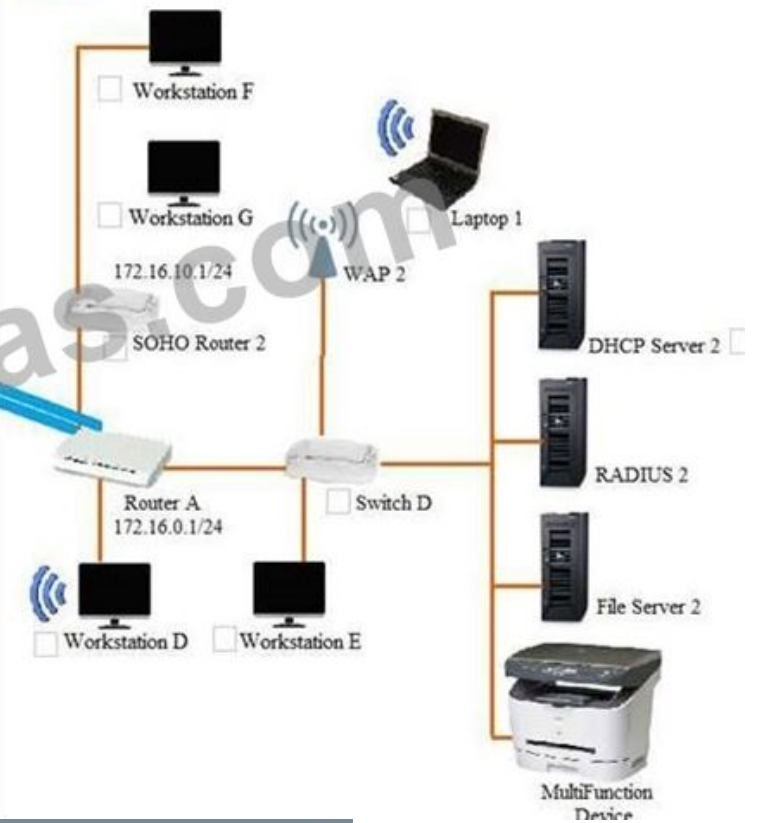

WORKSTATION A

IP Address	172.30.0.10
Netmask	255.255.255.0
Gateway	172.30.0.1

OK

WORKSTATION B

IP Address	172.30.0.14
Netmask	255.255.255.0
Gateway	172.30.0.1

OK

WORKSTATION C

IP Address	169.254.200.67
Netmask	255.255.255.0
Gateway	

OK

WORKSTATION D

IP Address	172.16.0.221
Netmask	255.255.255.0
Gateway	172.16.0.1

OK

WORKSTATION E

IP Address	172.16.0.21
Netmask	255.255.255.0
Gateway	172.16.0.1

OK

WORKSTATION F

IP Address	172.16.10.43
Netmask	255.255.255.0
Gateway	172.16.10.1

OK

WORKSTATION G

IP Address	172.16.10.120
Netmask	255.255.255.0
Gateway	172.16.10.1

OK

LAPTOP 1

IP Address	172.16.0.220
Netmask	255.255.255.0
Gateway	172.16.0.1

OK

LAPTOP 2

IP Address	172.30.0.10
Netmask	255.255.255.0
Gateway	172.30.0.1

OK

DHCP SERVER 1

IP Address	172.30.0.5
Netmask	255.255.255.0
Gateway	172.30.0.1

DHCP Scope	172.30.0.10-250
Gateway	172.30.0.1
DNS Servers	10.200.2.20, 10.200.3.20
DHCP Lease Time	8 days

OK

DHCP SERVER 2

IP Address	172.30.0.5
Netmask	255.255.255.0
Gateway	172.16.0.1

DHCP Scope	172.16.0.10-250
Gateway	172.16.0.1
DNS Servers	10.200.2.20, 10.200.3.20
DHCP Lease Time	8 days

OK

Part 2

Identify the reason as to why some users are unable to access the network.

- A. DHCP server scope is full and is not providing IP addresses.
- B. The NIC driver is not installed.
- C. WAN and LAN ports are reversed on the router.
- D. Workstation(s) are plugged into switch ports configured with half duplex.
- E. The site-to-site router was configured with the incorrect ACL.
- F. A wireless client is unable to associate to the AP.
- G. STP had disabled some of the ports on the switch.

Answer: F (LEAVE A REPLY)

NEW QUESTION: 276

A switch has detected duplicate broadcast messages sourced from a second port. The broadcasts continue to be transmitted and duplicated until the amount of traffic causes severe performance issues. Which of the following should be configured to prevent this behavior?

- A. BPDU guard
- B. DHCP snooping
- C. ARP protection
- D. Spanning tree

Answer: D (LEAVE A REPLY)

Explanation

NEW QUESTION: 277

Which of the following is an IPv6 transition mechanism in which network devices utilize IPv4 and

IPv6 at the same time?

- A. ISATAP
- B. Dual stack
- C. 6to4
- D. Teredo

Answer: D ([LEAVE A REPLY](#))

NEW QUESTION: 278

A network technician needs to configure a device with an embedded OS so it can be connected to a wireless handheld scanner. Which of the following technologies should be configured on the OS to create the wireless connection?

- A. Partial mesh
- B. Bus
- C. Ring
- D. Ad hoc

Answer: D ([LEAVE A REPLY](#))

NEW QUESTION: 279

The server team has just installed an application across three different servers. They are asking that all requests to the application are spread evenly across the three servers. Which of the following should the network team implement to fulfil the request?

- A. Proxy server
- B. UTM appliance
- C. Content filter
- D. Load balancer

Answer: D ([LEAVE A REPLY](#))

Section: (none)

NEW QUESTION: 280

A network administrator wants to increase the confidentiality of the system by hardening the authentication process. Currently, the users log in using usernames and passwords to access the system.

Which of the following will increase the authentication factor to three?

- A. Using a smart card and RSA token
- B. Adding a fingerprint reader to each workstation and providing a RSA authentication token
- C. Adding a fingerprint reader and retina scanner
- D. Enforcing a stronger password policy and using a hand geometry scan

Answer: B ([LEAVE A REPLY](#))

NEW QUESTION: 281

A network administrator reviews the following command output while troubleshooting a system

that is unable to connect to the www.comptia.com website:

```
MacOS:~ user$ ifconfig
eth0: FLAGS=8863<UP,BROADCAST,SMART,RUNNING,PROMISC,SIMPLEX,MULTICAST> mtu 1500
options=60<TS04,TS06>
ether ad:fa:bl:03:77:45
media autoselect <full-duplex>
status: inactive

MacOS:~ user$ dig www.comptia.com
;; global options: (debug, verbosity)
;; connection timed out; servers could be reached
```

Which of the following is the reason the system cannot connect?

- A. A cable is not connected to the NIC.
- B. The DNS server is under maintenance.
- C. The domain complia.com is having network issues.
- D. The interface eth0 is using an APIPA address.

Answer: [\(SHOW ANSWER\)](#)

NEW QUESTION: 282

169.254.0.100 is an IP address which would MOST likely come from which of the following?

- A. DNS
- B. CIDR
- C. APIPA
- D. DHCP

Answer: [C \(LEAVE A REPLY\)](#)

NEW QUESTION: 283

A customer cannot access a company's secure website. The company's network security is reviewing the firewall for the server and finds the following output:

Time	Action	Src IP	Src Port	Dst IP	Dst Port
0902	Allow	12.73.15.5	31865	10.5.0.10	80
1005	Deny	12.73.15.5	31866	10.5.0.10	443
1006	Deny	12.73.15.5	31890	10.5.0.10	443

Which of the following changes should be made to allow all customers to access the company's secure website?

- A. Allow 10.5.0.10 any 10.5.0.10 80
- B. Allow any any 10.5.0.10 443
- C. Allow any any 12.73.15.5 443
- D. Allow 10.5.0.10 443 any any

Answer: [D \(LEAVE A REPLY\)](#)

NEW QUESTION: 284

An office user cannot access local network drives but has full access to the Internet. A technician troubleshoots the issue and observes the following output of the ipconfig command:

WINDOWS IP CONFIGURATION

```
Ethernet LAN Adapter: 980GTS  
Connection-specific DNS Suffix: ...comptia.net  
IPv4 Address: .....10.0.5.99  
Subnet Mask: .....255.255.255.0  
Default Gateway: ...10.0.5.1
```

```
Wireless LAN Adapter: FastWifi 99  
Connection-specific DNS Suffix: ...guestwireless.local  
IPv4 Address: .....172.16.0.5  
Subnet Mask: .....255.255.255.0  
Default Gateway: ...172.16.0.254
```

Which of the following would MOST likely allow the network drives to be accessed?

- A. Disable the WLAN adapter
- B. Check the wireless DHCP configuration
- C. Disable the LAN adapter
- D. Update the WLAN adapter driver

Answer: A ([LEAVE A REPLY](#))

NEW QUESTION: 285

A technician is diagnosing an issue with a new T1 connection. The router is configured, the cable is connected, but the T1 is down. To verify the configuration of the router, which of the following tools should the technician use?

- A. Loopback adapter
- B. Cable tester
- C. Multimeter
- D. Tone generator

Answer: A ([LEAVE A REPLY](#))

NEW QUESTION: 286

Joe a network technician wants to locally back up several router and switch configurations. He wants to store them on a server that can be accessed easily for recovery without authentication. Which of the following servers should Joe use?

- A. Telnet
- B. TFTP
- C. LDAP
- D. Samba

Answer: D ([LEAVE A REPLY](#))

Valid N10-007 Dumps shared by PrepPdf.com for Helping Passing N10-007 Exam!
PrepPdf.com now offer the **newest N10-007 exam dumps**, the PrepPdf.com N10-007 exam **questions have been updated** and **answers have been corrected** get the **newest** PrepPdf.com N10-007 dumps with Test Engine here:
<https://www.preppdf.com/CompTIA/N10-007-prepaway-exam-dumps.html> (690 Q&As Dumps, **40%OFF Special Discount: Exam-Tests**)

NEW QUESTION: 287

Which of the following can be done to implement network device hardening (Select TWO).

- A. Implement spanning tree
- B. perform VLAN hooping
- C. Patch and update
- D. performs backups.
- E. Change default admin password

Answer: (SHOW ANSWER)

Network devices come with default credentials, the username and password that enables you to log into the device for configuration. Changing default credentials should be the first step in hardening a new device. As with any other system, avoiding common passwords adds security. Keep network devices up to date. That means upgrading firmware, patching and updating as necessary to close any security gaps exposed over time.

Services on network devices like routers include common things, like Telnet and HTTP access; and also things you don't normally see, like TCP and UDP small services, debugging and testing tools that primarily use ports 20 and lower. If enabled, these services can be used to launch DoS and other attacks.

All modern Cisco devices have

these disabled; Cisco's hardening rules insist on disabling unnecessary services.

Using secure protocols hardens network devices. Don't use Telnet to access a managed switch or router, for example, but use SSH so that the communication is encrypted.

Disabling unused ports on network devices enhances port security for access control.

This includes standard IP ports and device ports, both physical and virtual for the latter.

NEW QUESTION: 288

A network technician is considering opening ports on the firewall for an upcoming VoIP PBX implementation. Which of the following protocols is the technician MOST likely to consider?

(Choose three.)

- A. SIP
- D. SMB
- B. NTP
- E. ICMP
- C. H.323
- F. RTP
- G. IPSec
- H. RDP

Answer: A,C,F (LEAVE A REPLY)

Section: (none)

NEW QUESTION: 289

Your company recently purchased a new building down the street from the existing office. For each of the tasks below, select the appropriate antenna type and encryption object for all wireless access point (AP).

1. Create an encrypted wireless connection between the two buildings that BEST controls signal propagation, while maximizing security.
2. Restrict the wireless signal generated by the access points (APs) inside Building 1, so that it minimizes broadcast beyond the building.
3. Maximize wireless coverage inside Building 1.
4. Building 1's internal wireless network is for visitors only and must not require any special configuration on the visitor's device to connect.

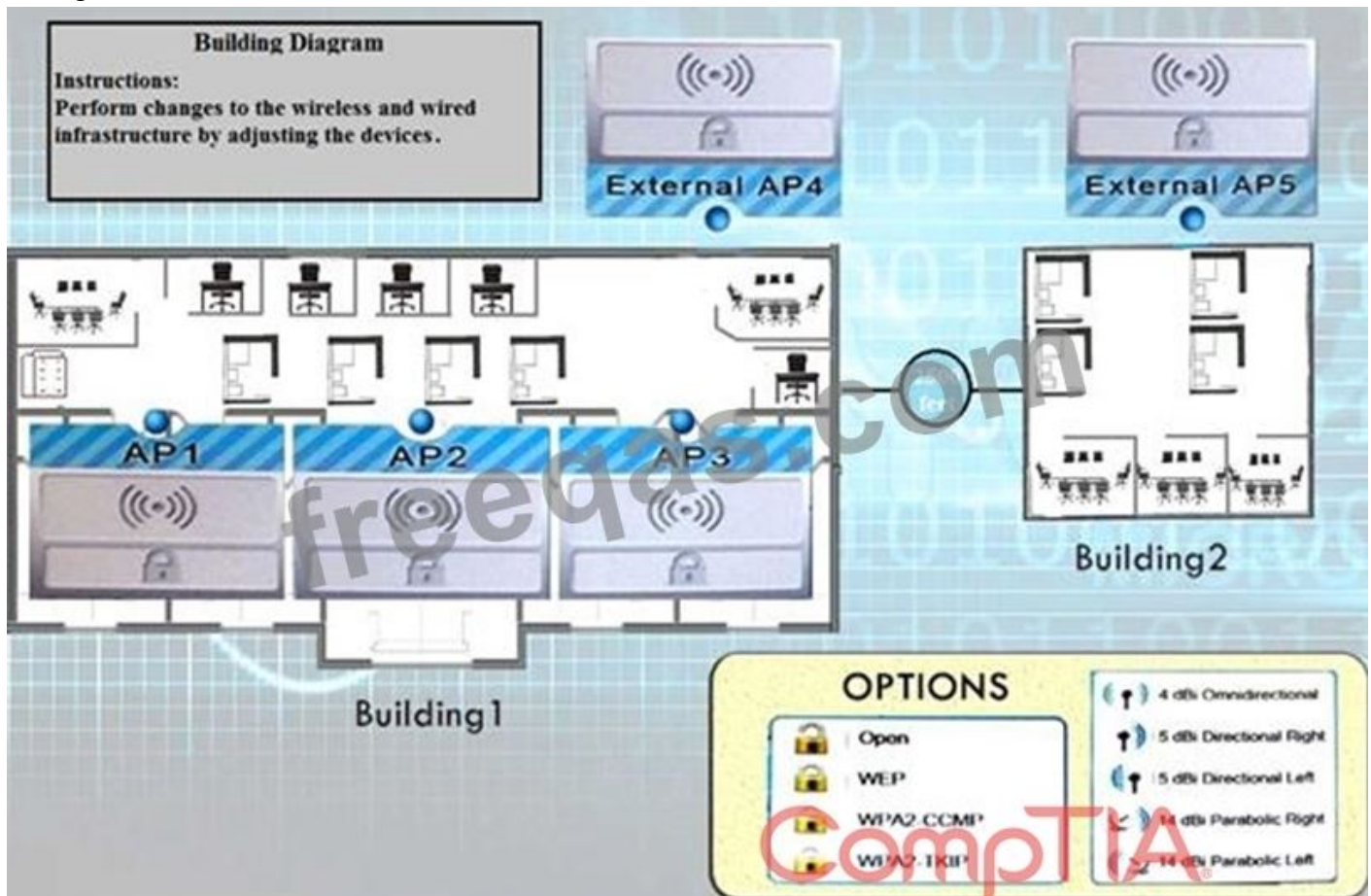

Instructions: When you have completed the simulation, select the Done button to submit.

Answer:

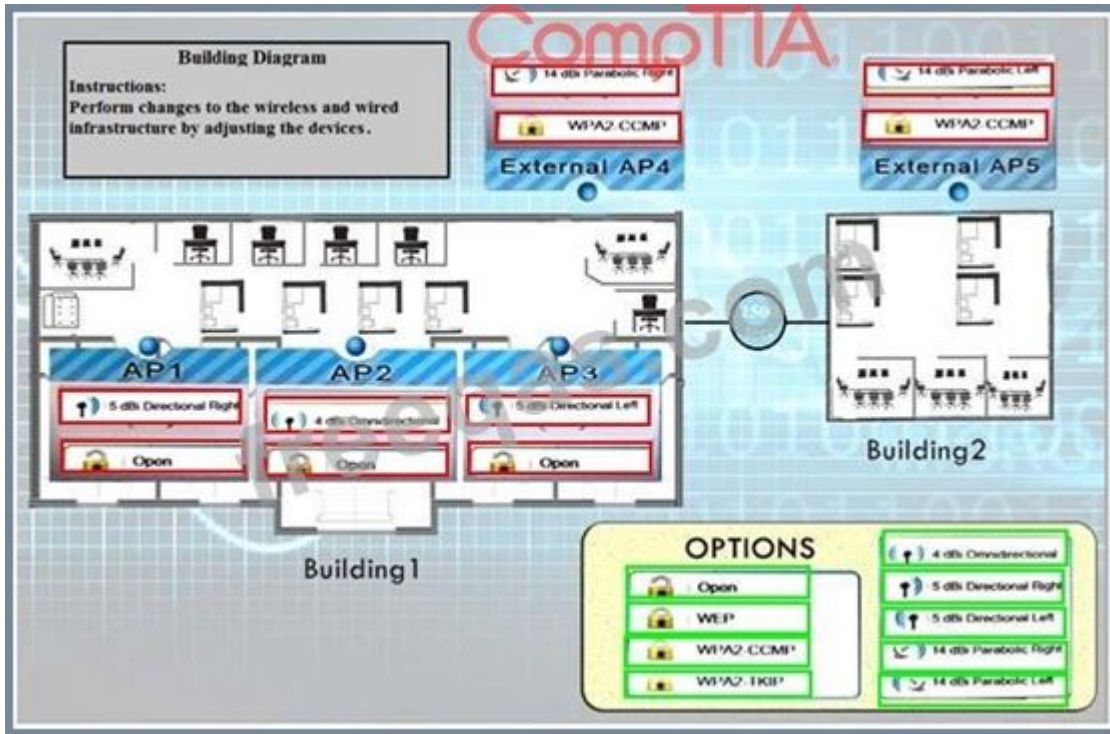

NEW QUESTION: 290

Corporate headquarters provided your office a portion of their class B subnet to use at a new office location.

Range Given: 172.30.232.0/24

Sales 57 devices

HR 23 devices

IT 12 devices

Finance 32 devices

Marketing 9 devices

INSTRUCTIONS

Allocate the minimum number of addresses (using CIDR notation) needed to accommodate each department.

After accommodating each department, identify the unused portion of the subnet by responding to the question on the graphic.

All drop downs must be filled.

If at any time you would like to bring back the initial state of the simulation, please click the Reset All button.

Network Subnet Diagram

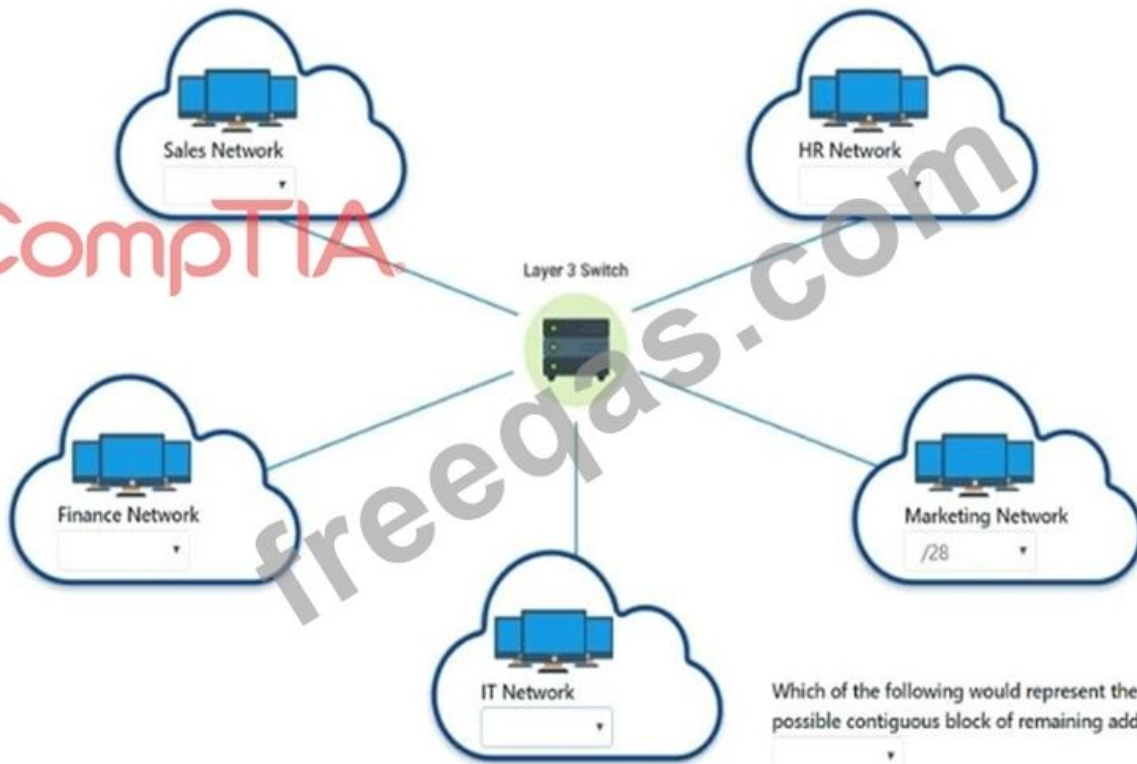

- /0
- /1
- /2
- /3
- /4
- /5
- /6
- /7
- /8
- /9
- /10
- /11
- /12
- /13
- /14
- /15
- /16
- /17
- /18
- /19
- /20
- /21
- /22
- /23
- /24
- /25
- /26
- /27
- /28
- /29
- /30
- /31
- /32

CompTIA



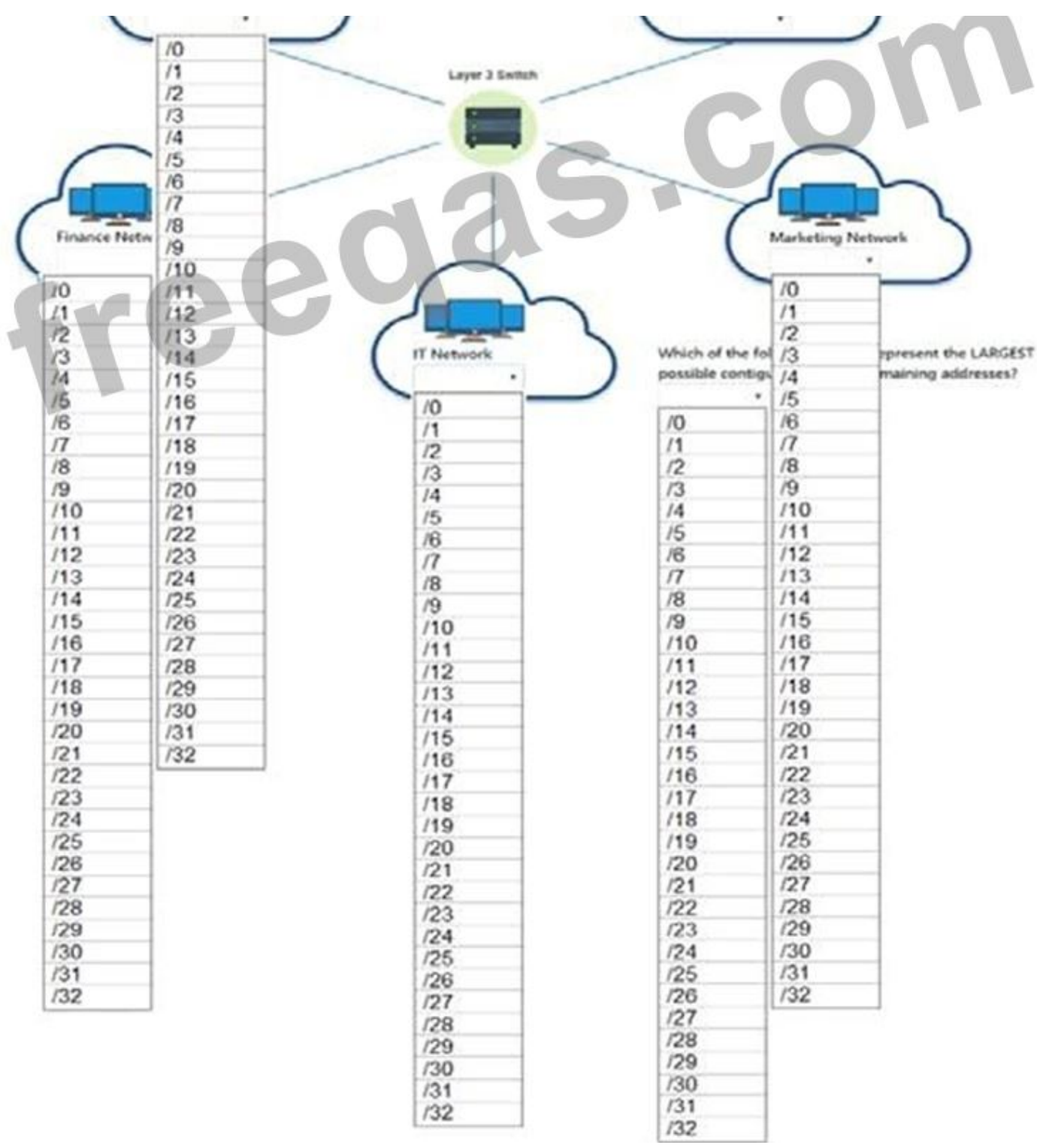

Answer:

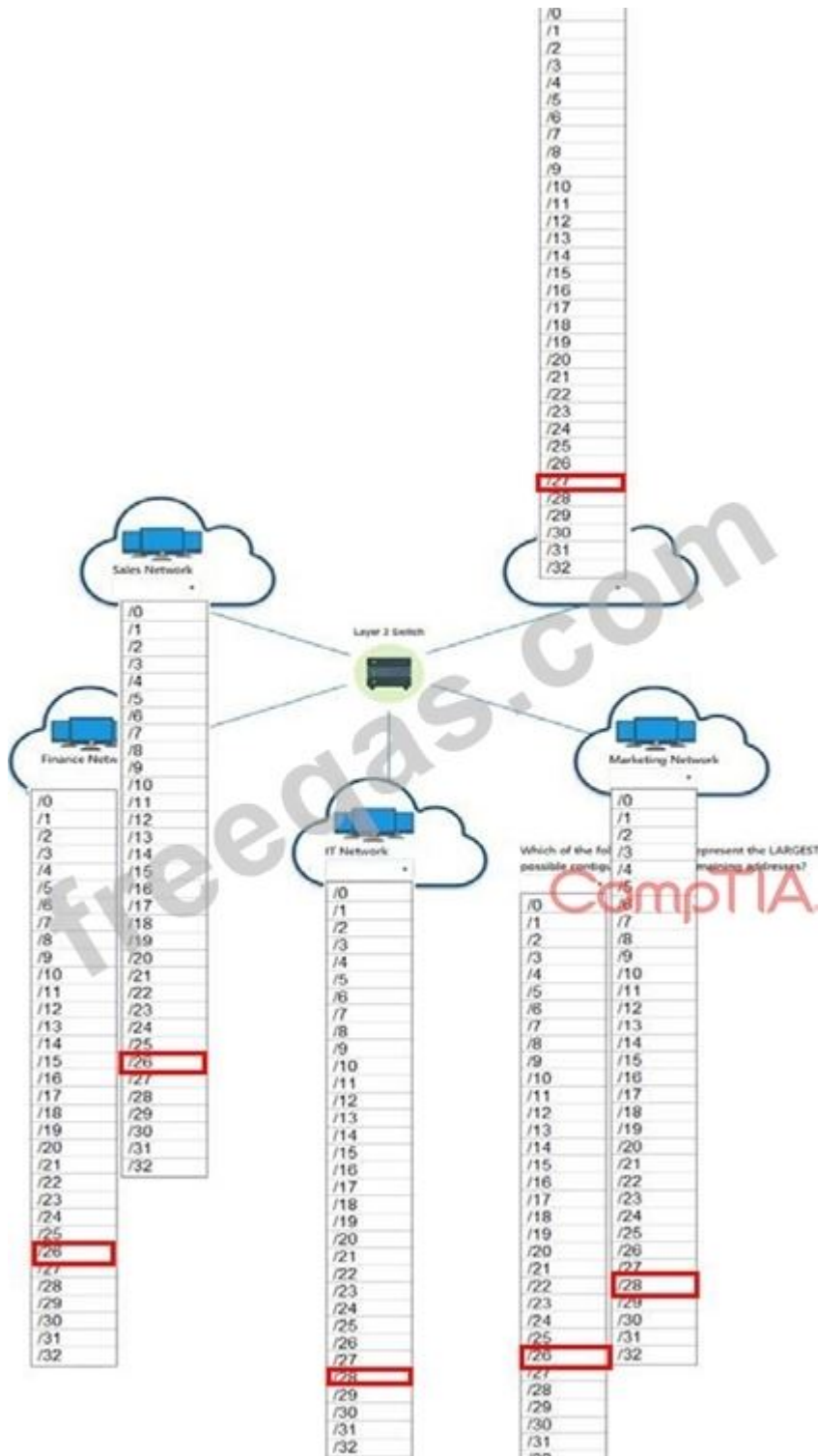

NEW QUESTION: 291

A network technician is installing a wireless solution. The solution needs to support new and legacy wireless network clients at the maximum possible speed. Which of the following wireless standards should the technician install?

- A. 802.11a
- B. 802.11ac
- C. 802.11b
- D. 802.11g
- E. 802.11n

Answer: ([SHOW ANSWER](#))

Explanation/Reference:

NEW QUESTION: 292

A network administrator suspects an employee of using the company's Internet connection to download illegal content. Which of the following can be used to inspect ongoing network traffic?

- A. Toner probe
- B. Packet sniffer
- C. OTDR
- D. Syslog server

Answer: B ([LEAVE A REPLY](#))

NEW QUESTION: 293

A new printer was assigned a static IP address within the DHCP scope of a QA subnet. There are 243 workstations on the LAN five servers, and four existing printers on the network The network administrator configured the network with the following parameters

192.168.51 -192 168.5 5 static IPs assigned to servers

192.168.5.6 -192 168.5 250 DHCP scope for workstations

192.168.5.251 -192.168.5 254 static IPs assigned to printers

Which of the following should the network administrator perform to minimize the disruption to the users and keep the LAN secure while setting up the new printer?

- A. Reconfigure the subnet mask for the LAN
- B. Assign a public IP address to the printer.
- C. Increase the DHCP scope by one address
- D. Create an IP reservation for the printer

Answer: D ([LEAVE A REPLY](#))

NEW QUESTION: 294

Which of the following is the MOST secure type of remote administration?

- A. RDP over SSLv2 HTTPS terminal services gateway
- B. HTTP over WPA2-TKIP WiFi
- C. SSH over iPSec client-to-site VPN
- D. Telnet over PSTN

Answer: ([SHOW ANSWER](#))

NEW QUESTION: 295

Tenants access multiple wireless networks in a building. Users report intermittent connectivity.

Which of the following is the MOST likely cause of the problem?

- A. The SSIDs are incompatible and should be renamed.
- B. The channels are overlapping with other wireless networks and should be changed.
- C. The users have incompatible wireless network cards and should upgrade.

D. The default idle period for logoff is too short and should be changed to a longer limit.

Answer: B ([LEAVE A REPLY](#))

NEW QUESTION: 296

A bookstore uses a Faraday cage to comply with credit card regulations. Customers report that their cellular phones have no signal when they are in the bookstore. Which of the following is the MOST likely cause?

- A. The Faraday cage is creating latency on the cellular network
- B. The Faraday cage is creating attenuation of the cellular network
- C. The Faraday cage is creating interference within the bookstore
- D. The Faraday cage prevents access by redirecting signals

Answer: ([SHOW ANSWER](#))

NEW QUESTION: 297

A company has a web-based application that is used by many different departments. The company has experienced some overload of resources on the database server. The network administrator implements a network device in between the servers and the database. Which of the following BEST describes the purpose of this device?

- A. Load balancing and providing high availability
- B. Port sniffing and protocol analysis
- C. Clustering and NIC teaming
- D. Content filtering and network analysis

Answer: A ([LEAVE A REPLY](#))

NEW QUESTION: 298

A network technician needs to configure a device with an embedded OS so it can be connected to a wireless handheld scanner. Which of the following technologies should be configured on the OS to create the wireless connection?

- A. Partial mesh
- B. Ad hoc
- C. Ring
- D. Bus

Answer: ([SHOW ANSWER](#))

Explanation/Reference:

NEW QUESTION: 299

A network technician is troubleshooting an issue routing TCP packets to an email server. At which of the following OSI layers is the issue occurring?

- A. Layer 4 - Transport
- B. Layer 1 - Physical
- C. Layer 7 - Application

D. Layer 3 - Network

Answer: D ([LEAVE A REPLY](#))

NEW QUESTION: 300

A customer has asked a technician to upgrade the wireless router to the fastest speed possible. The technician performs a site survey and notices several older devices will not be able to connect to router that operates in the 5GHz range. Which of the following options should the technician suggest to the customer?

A. 802.11ac

B. 802.11b

C. 802.11a

D. 802.11n

Answer: A ([LEAVE A REPLY](#))

NEW QUESTION: 301

A network engineer is trying to determine where to place a firewall based on the flow of traffic. Which of the following types of documentation would assist the engineer in doing this?

A. Network configuration

B. Rack diagram

C. Change management

D. Network diagram

Answer: D ([LEAVE A REPLY](#))

Valid N10-007 Dumps shared by PrepPdf.com for Helping Passing N10-007 Exam!
PrepPdf.com now offer the **newest N10-007 exam dumps**, the PrepPdf.com N10-007 exam **questions have been updated** and **answers have been corrected** get the **newest** PrepPdf.com N10-007 dumps with Test Engine here:
<https://www.preppdf.com/CompTIA/N10-007-prepaway-exam-dumps.html> (690 Q&As Dumps, **40%OFF Special Discount: Exam-Tests**)

NEW QUESTION: 302

Users are reporting Internet connectivity issues. The network administrator wants to determine if the issues are internal to the company network or if there is an issue with the ISP. Which of the following tools should be used to BEST determine where the outage is occurring?

A. ping

B. nslookup

C. netstat

D. traceroute

Answer: D ([LEAVE A REPLY](#))

NEW QUESTION: 303

An office user cannot access local network drives but has full access to the Internet. A technician troubleshoots the issue and observes the following output of the ipconfig command:

Windows IP Configuration

```
Ethernet LAN Adapter: 980GTS
Connection-specific DNS Suffix: ...comptia.net
IPv4 Address: .....10.0.5.99
Subnet Mask: .....255.255.255.0
Default Gateway: ...10.0.5.1
```

```
Wireless LAN Adapter: FastWifi 99
Connection-specific DNS Suffix: ...guestwireless.local
IPv4 Address: .....172.16.0.5
Subnet Mask: .....255.255.255.0
Default Gateway: ...172.16.0.254
```

Which of the following would MOST likely allow the network drives to be accessed?

- A. Disable the LAN adapter
- B. Update the WLAN adapter driver
- C. Check the wireless DHCP configuration
- D. Disable the WLAN adapter

Answer: ([SHOW ANSWER](#))

NEW QUESTION: 304

A network technician needs to upgrade a production Windows server to the latest service pack. In which of the following should the work plan and recovery procedure be documented?

- A. IDF/MDF
- B. SOPs
- C. Inventory management
- D. Change management

Answer: B ([LEAVE A REPLY](#))

NEW QUESTION: 305

Which of the following protocols can be both connection-oriented and connectionless?

- A. 20 FTP
- B. 53 DNS
- C. 67 DHCP
- D. 80 HTTP

Answer: B ([LEAVE A REPLY](#))

Section: (none)

Explanation/Reference:

NEW QUESTION: 306

Which of the following layers of the OSI model make up the Network Interface layer of the TCP/IP model? (Select TWO).

- A. Data Link
- B. Physical
- C. Application
- D. Transport
- E. Network
- F. Presentation

Answer: ([SHOW ANSWER](#))

NEW QUESTION: 307

A network technician installs a web server on the firewall. Which of the following methods should the technician implement to allow access to outside users without giving access to the inside network?

- A. NTP
- B. SNMP
- C. VLAN
- D. DMZ

Answer: D ([LEAVE A REPLY](#))

NEW QUESTION: 308

An attacker quickly gains administrative access to a network device. Which of the following MOST likely allowed the attacker to guess the password?

- A. A brute-force attack
- B. Rainbow tables
- C. A hash comparison
- D. Man in the middle

Answer: ([SHOW ANSWER](#))

NEW QUESTION: 309

A network technician has to integrate three legacy industrial devices into the existing wireless network.

The devices only support 802.11b and TKIP. Which of the following should the technician do to connect these devices to the wireless network with the restrictive settings while not affecting the performance of the other users? (Select Two).

- A. Change the encryption to WPA@ personal.
- B. Enable MAC filtering.
- C. Create a second SSID that uses WPA personal.
- D. Change the encryption to WPA2 Enterprise.

Answer: D ([LEAVE A REPLY](#))

NEW QUESTION: 310

A company wants to only allow incoming HTTP and HTTPS traffic on their public wireless network. Which of the following port numbers should be the only allowed open ports on the firewall to accomplish this? (Select TWO).

- A. 143
- B. 20
- C. 80
- D. 8080
- E. 443

Answer: C,E ([LEAVE A REPLY](#))

NEW QUESTION: 311

A network administrator configures a router with the following IP address information:

Gigabit Ethernet 1 Interface: 10.10.0.1/24

Serial 0 Interface: 10.10.0.253/30

Clients are connected to a switch on the gigabit Ethernet interface; the ISP is connected to the Serial 0 interface. When the router configuration is complete and client devices are reconfigured, all clients report that they are unable to connect to the Internet. Which of the following is the MOST likely reason?

- A. The router was configured with an incorrect IP address
- B. The router was configured with an incorrect loopback address
- C. The router was configured with an incorrect subnet mask
- D. The router was configured with an incorrect default gateway

Answer: C ([LEAVE A REPLY](#))

NEW QUESTION: 312

After recent changes to the pictured network, several users are unable to access the servers. Only PC1, PC2, PC3, and PC4 are clickable and will give you access to the command prompt and the adapter configuration tabs.

INSTRUCTIONS

Verify the settings by using the command prompt, after making any system changes.

Next, restore connectivity by making the appropriate changes to the infrastructure.

If at any time you would like to bring back the initial state of the simulation, please click the Reset All button.

Network Diagram

CompTIA®

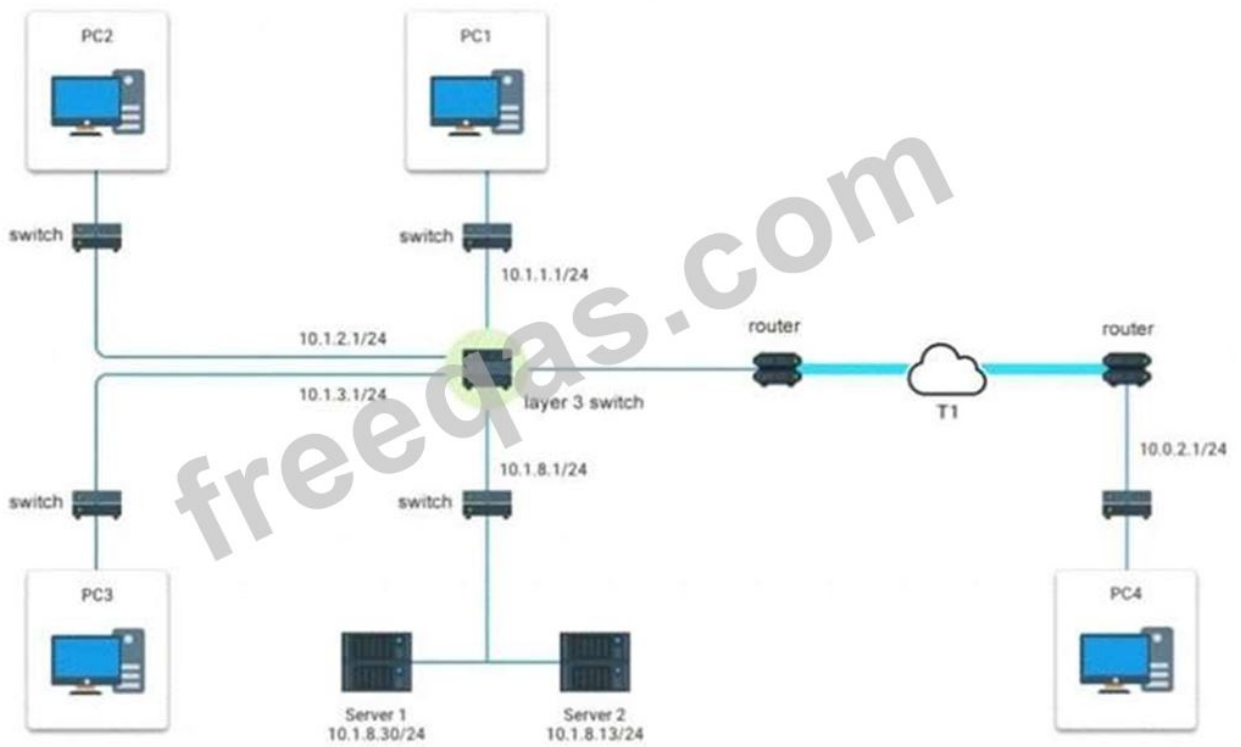

Adapter Configuration

Command Prompt

You can get IP settings automatically if your network supports this capability. Otherwise, you need to ask your network administrator for the appropriate settings.

Obtain an IP address automatically

Use the following IP address

IP address

Subnet mask

Default gateway

Obtain DNS server address automatically

Use the following DNS server addresses

Preferred DNS server

Alternate DNS server

Validate settings upon exit

Advanced...

APPLY

CANCEL



PC2 [Close]

Adapter Configuration | **Command Prompt**

You can get IP settings automatically if your network supports this capability. Otherwise, you need to ask your network administrator for the appropriate settings.

Obtain an IP address automatically

Use the following IP address

IP address	10	.	1	.	2	.	129
Subnet mask	255	.	255	.	255	.	0
Default gateway	10	.	1	.	2	.	1

Obtain DNS server address automatically

Use the following DNS server addresses

Preferred DNS server	10	.	1	.	8	.	13
Alternate DNS server		.		.		.	

Validate settings upon exit

[Advanced...](#)

APPLY | **CANCEL**

PC2



Adapter Configuration

Command Prompt

CompTIA

```
C:\> ping |
```

freeqas.com

Adapter Configuration

Command Prompt

You can get IP settings automatically if your network supports this capability. Otherwise, you need to ask your network administrator for the appropriate settings.

Obtain an IP address automatically

Use the following IP address

IP address	10	.	1	.	3	.	129
Subnet mask	255	.	255	.	255	.	128
Default gateway	10	.	1	.	3	.	1

Obtain DNS server address automatically

Use the following DNS server addresses

Preferred DNS server	10	.	1	.	8	.	13
Alternate DNS server		.		.		.	

Validate settings upon exit

Advanced...

APPLY

CANCEL

CompTIA

PC3



Adapter Configuration

Command Prompt

c:\> |

freeqas.com
CompTIA.

Adapter Configuration

Command Prompt

You can get IP settings automatically if your network supports this capability. Otherwise, you need to ask your network administrator for the appropriate settings.

Obtain an IP address automatically

Use the following IP address

IP address

10

.

0

.

2

.

129

Subnet mask

255

.

255

.

255

.

0

Default gateway

10

.

1

.

2

.

1

Obtain DNS server address automatically

Use the following DNS server addresses

Preferred DNS server

10

.

1

.

8

.

13

Alternate DNS server

.

.

.

Validate settings upon exit

Advanced...

APPLY

CANCEL



Answer:

See explanation below.

Explanation

On PC3, change the subnet mask to 255.255.255.0. When it is set to 255.255.255.128, then the PC with a .129 address will not be on the same subnet as the default gateway which is .1 On PC4, change the default gateway to 10.0.2.1. It has been incorrectly set as 10.1.2.1.

NEW QUESTION: 313

Due to an increase in wireless demand, 50 additional access points were installed as part of an expansion project. Each device was configured and managed separately, working with its own configuration. Which of the following network devices would assist the network team with reducing complexity and enforcing policies on the WLAN?

- A. Wireless controller
- B. Wireless range extender
- C. Wireless load balancer
- D. Wireless analyzer

Answer: A ([LEAVE A REPLY](#))

Explanation/Reference:

NEW QUESTION: 314

Which of the following is the SHORTEST way to write 2001:0000:0d58:0000:0000:0095:7565:0001 in

proper IPv6 shorthand?

- A. 2001::d58::95:7565:1
- B. 2001:0:d58::95:7565:1
- C. 2001:0:0d58::95:7565:1
- D. 2001:0:d58:0:0:95:7565:1

Answer: B ([LEAVE A REPLY](#))

NEW QUESTION: 315

Joe an ex-employee from accounting, changed the configurations on several network devices on his last day of work. Which of the following is the MOST likely reason a non-IT employee was able to gain access to network devices?

- A. Allowed unsecure protocols
- B. Left default passwords
- C. Allowed unnecessary services
- D. Left virtual ports open

Answer: ([SHOW ANSWER](#)**)**

NEW QUESTION: 316

A technician must install and configure a network device in a building with 20 classrooms. Each room must be on a separate subnet and should not be able to see traffic from other subnets.

Which of the following is the MOST cost-effective solution?

- A. A router with interfaces connected to a switch in each room
- B. A VoIP endpoint connected to a hub for each network
- C. A firewall with DHCP pools for each subnet
- D. A switch with VLANs created for each segment

Answer: D ([LEAVE A REPLY](#))

Valid N10-007 Dumps shared by PrepPdf.com for Helping Passing N10-007 Exam!
PrepPdf.com now offer the **newest N10-007 exam dumps**, the PrepPdf.com N10-007 exam **questions have been updated** and **answers have been corrected** get the **newest** PrepPdf.com N10-007 dumps with Test Engine here:
<https://www.preppdf.com/CompTIA/N10-007-prepaway-exam-dumps.html> (**690** Q&As Dumps,
40%OFF Special Discount: **Exam-Tests**)

NEW QUESTION: 317

Given the table below:

Host Name	IP Address
Host A	192.168.10.22/24
Host B	192.168.10.23/24
Host C	192.168.11.125/24
Host D	192.168.11.53/24
Host E	192.168.5.15/24

Which of the following addresses can Host E send a packet to that will reach Hosts C and D, but not Hosts A and B?

- A. 192.168.11.0
- B. 192.168.5.1
- C. 192.168.255.255
- D. 192.168.11.255

Answer: ([SHOW ANSWER](#))

NEW QUESTION: 318

A network technician recently installed a new server on a network. The technician must ensure the server does not have any unnecessary services running. The IP address of the server is 204.211.38.50 Which of the following commands would allow the technician to make this determination?

- A. route
- B. nslookup
- C. runap
- D. pathping

Answer: B ([LEAVE A REPLY](#))

NEW QUESTION: 319

A company's server-naming convention is overly complicated. The systems administrator wants to change the naming convention to make it easier for users to remember which hosts they should log into. However, renaming servers is complicated and requires some downtime. Which of the following DNS record types would accomplish this goal without requiring servers to be renamed?

- A. A
- B. CNAME
- C. TXT
- D. SRV

Answer: ([SHOW ANSWER](#))

NEW QUESTION: 320

A network technician is segmenting a network to allow for unauthenticated public connections to a

server. Which of the following devices would BEST safeguard the internal network from the public facing server?

- A. Intrusion detection system
- B. Proxy server
- C. Firewall
- D. Layer 3 switch
- E. Router

Answer: C ([LEAVE A REPLY](#))

NEW QUESTION: 321

A system administrator receives reports from users of odd behavior in regard to a recently installed server.

While reviewing the server network configuration, the systems administrator does both a forward and a reverse DNS lookup on the host, along with the network adapter configuration.

```
$ host server.company.com
server.company.com has address 129.168.0.100
server.company.com is handled by 100 mail.company.com
$ host 192.168.0.100
100.0.168.192.in-addr.arpa domain name pointer web.company.com
$ host web.company.com
server.company.com has address 129.168.0.50
server.company.com is handled by 100 mail.company.com
$ ifconfig -a
eth0Link encap:Ethernet HWaddr 00:30:48:9D:06:73
Inet addr:192.168.0.100 Bcast:192.168.0.255 Mask:255.255.255.0
UP BROADCAST RUNNING MULTICAST MTU:1500 Metric:1
lo0Link encap:Local Loopback
inet addr:127.0.0.1 Mask:255.0.0.0
UP LOOPBACK RUNNING MTU:16436 Metric:1
```

Which of the following is the problem identified in the output above?

- A. The server IP address is incorrectly configured.
- B. The DNS lookup entry is incorrectly configured.
- C. There is no reverse DNS entry for this host.
- D. The reverse DNS entry is pointing to a different host.

Answer: B ([LEAVE A REPLY](#))

NEW QUESTION: 322

A manufacturing company has signed an agreement with another company to collaborate on an upcoming project. Both companies require secure and persistent access to resources on each others' networks. Which of the following remote access technologies should the companies implement to satisfy their requirements?

- A. Out-of-band management
- B. DMZ networks
- C. Site-to-site VPN
- D. SFTP site

Answer: C ([LEAVE A REPLY](#))

NEW QUESTION: 323

A network engineer configured new Firewalls with the correct configuration to be deployed to each remote branch. Unneeded services were disabled, and all firewall rules were applied successfully. Which of the following should the network engineer perform NEXT to ensure all the firewalls are hardened successfully?

- A. Configure the log settings on the firewalls to the central syslog server.
- B. Use the same complex passwords on all firewalls.
- C. Ensure an implicit permit rule is enabled.
- D. Update the firewalls with current firmware and software.

Answer: C ([LEAVE A REPLY](#))

NEW QUESTION: 324

A network technician configures a firewall's ACL to allow outgoing traffic for several popular services such as email and web browsing. However, after the firewall's deployment, users are still unable to retrieve their emails. Which of the following would BEST resolve this issue?

- A. Set the firewall to operate in transparent mode
- B. Allow the firewall to accept inbound traffic to ports 80, 110, 143, and 443
- C. Allow the firewall to accept inbound traffic to ports 25, 67, 179, and 3389
- D. Allow the firewall to accept inbound traffic to ports 21, 53, 69, and 123

Answer: B ([LEAVE A REPLY](#))

NEW QUESTION: 325

According to the troubleshooting methodology, which of the following steps will help a technician gather information about a network problem? (Choose two.)

- A. Question users
- B. Establish a theory of probable cause
- C. Test solutions.
- D. Duplicate the problem
- E. Implement preventive measures.
- F. Document findings

Answer: ([SHOW ANSWER](#))

NEW QUESTION: 326

A network administrator is looking for an out-of-band method for accessing the console ports of a company's network devices when working remotely. Which of the following can be deployed as a solution?

- A. A hub
- B. A modem
- C. A bridge
- D. A WAP

Answer: A ([LEAVE A REPLY](#))

NEW QUESTION: 327

Which of the following storage connection types should be used to allow the consolidation of the physical connections for SAN and LAN in just one Layer 2 protocol?

- A. Fibre Channel
- B. SCSI
- C. T1/E1
- D. FCoE

Answer: D ([LEAVE A REPLY](#))

Explanation

NEW QUESTION: 328

Which of the following services describes a distribution model in which applications are hosted by a service provider and made available to users?

- A. MaaS
- B. IaaS
- C. SaaS
- D. PaaS

Answer: C ([LEAVE A REPLY](#))

NEW QUESTION: 329

Which of the following is a system of notation that uses base 16 rather than base 10?

- A. Hex
- B. Octal
- C. Binary
- D. CIDR

Answer: A ([LEAVE A REPLY](#))

Explanation

Which of the following devices can be used to offload outbound web server SSL encryption overhead?

NEW QUESTION: 330

- A. NIPS
- B. VPN connector

C. Proxy server

D. Content filter

Answer: ([SHOW ANSWER](#))

NEW QUESTION: 331

A technician needs to limit the amount of broadcast traffic on a network and allow different segments to communicate with each other. Which of the following options would satisfy these requirements?

A. Add a router and enable OSPF.

B. Add a layer 3 switch and create a VLAN.

C. Add a bridge between two switches.

D. Add a firewall and implement proper ACL.

Answer: B ([LEAVE A REPLY](#))

We can limit the amount of broadcast traffic on a switched network by dividing the computers into logical network segments called VLANs.

A virtual local area network (VLAN) is a logical group of computers that appear to be on the same LAN even if they are on separate IP subnets. These logical subnets are configured in the network switches. Each VLAN is a broadcast domain meaning that only computers within the same VLAN will receive broadcast traffic.

To allow different segments (VLAN) to communicate with each other, a router is required to establish a connection between the systems. We can use a network router to route between the VLANs or we can use a 'Layer 3' switch. Unlike layer 2 switches that can only read the contents of the data-link layer protocol header in the packets they process, layer 3 switches can read the (IP) addresses in the network layer protocol header as well.

Valid N10-007 Dumps shared by PrepPdf.com for Helping Passing N10-007 Exam!
PrepPdf.com now offer the **newest N10-007 exam dumps**, the PrepPdf.com N10-007 exam **questions have been updated** and **answers have been corrected** get the **newest** PrepPdf.com N10-007 dumps with Test Engine here:
<https://www.preppdf.com/CompTIA/N10-007-prepaway-exam-dumps.html> (**690** Q&As Dumps,
40%OFF Special Discount: **Exam-Tests**)

NEW QUESTION: 332

An attacker has flooded the hardware tables of a switch to forward traffic to the attacker's IP address rather than the default router. The traffic received is copied in real time, and then forwarded to the default router transparently from the end-user perspective. Which of the following attacks are occurring in this scenario?

(Select TWO).

A. Evil twin

- B. DNS poisoning
- C. ARP poisoning
- D. Ransomware
- E. Reflective
- F. Man-in-the-middle

Answer: C,F (LEAVE A REPLY)

NEW QUESTION: 333

A network technician has implemented ACLs to limit access to cloud-based file storage. Which of the following security mechanisms has the technician enforced?

- A. WPA
- B. WAF
- C. TPM
- D. DLP
- E. IDS

Answer: B (LEAVE A REPLY)

NEW QUESTION: 334

You have been tasked with testing a CAT5e cable. A summary of the test results can be found on the screen.

Step 1: Select the tool that was used to create the cable test results.

Step 2: Interpret the test results and select the option that explains the results. After you are done with your analysis, click the 'Submit Cable Test Analysis' button.

Cable Crimp

Instructions: You have determined that the original crimp is faulty using the T568B cabling standard. Drag the appropriate tool to the crimp. When you are finished, click the Done button.

RJ-45 Connector

1
2
3
4
5
6
7
8

Question:
You have been tasked with testing a CAT5e cable. A summary of the test results can be found on the screen.
Step 1: Select the tool that was used to create the cable test results.
Step 2: Interpret the test results and select the option that explains the results. After you are done with your analysis, click the 'Submit Cable Test Analysis' button.

Done Reset Hi

This window can be resized. ATA Simulation

Reset Cable

CompTIA

Cable Test

Step 1: Select the tool that was used to create the cable test results.

Cable Test Result		
1, 2	Open	7ft
3, 6	Short	7ft
4, 5	Open	7ft
7, 8	Open	7ft

→

Tool Choices	
<input type="checkbox"/>	Crimper
<input type="checkbox"/>	Cable Certifier
<input type="checkbox"/>	Multimeter
<input type="checkbox"/>	Punch Down Tool
<input type="checkbox"/>	Protocol Analyzer
<input type="checkbox"/>	OTDR
<input type="checkbox"/>	Toner Probe

A Cable Certifier provides "Pass" or "Fail" information in accordance with industry standards but can also show detailed information when a "Fail" occurs. This includes shorts, the wire pairs involved and the distance to the short. When a short is identified, at the full length of the cable it means the cable has not been crimped correctly.

Step 1 Select the tool that was used to create the cable test results

- Cable Certifier
- Punch Down Tool
- Toner Probe
- Crimper
- OTDR
- Protocol Analyzer
- Multimeter

Step 2 Interpret the test results and select the option that explains the results

- Correctly crimped cable
- Incorrectly crimped cable

Submit

Answer:

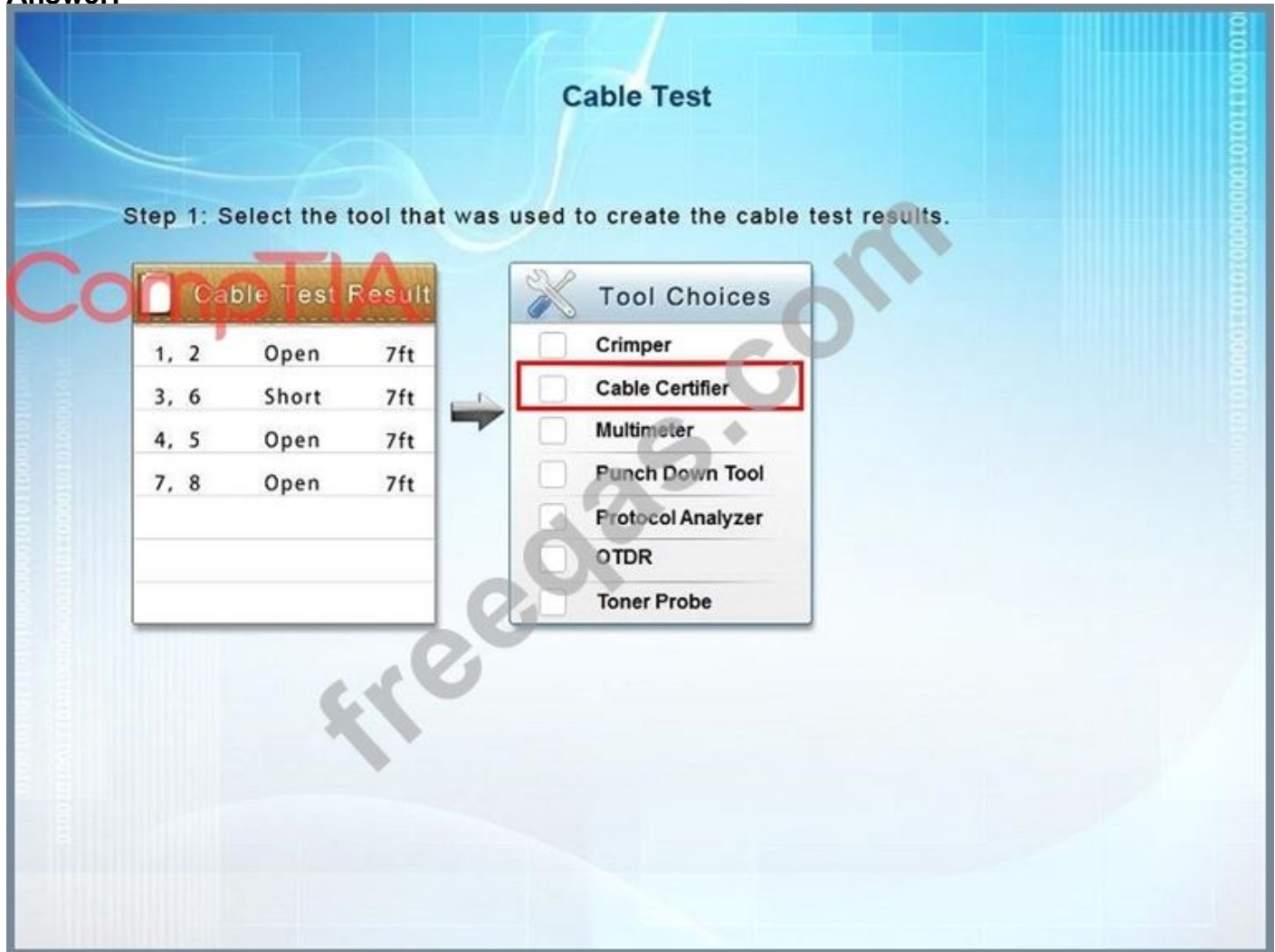

NEW QUESTION: 335

Which of the following specifications would Sara, an administrator, implement as a network access control?

- A. 802.1q
- B. 802.1x
- C. 802.11n
- D. 802.3

Answer: B ([LEAVE A REPLY](#))

NEW QUESTION: 336

Kim, a user, took a laptop on vacation and made changes to the configuration in order to use the device at the hotel. She can reach the Internet, but cannot access any internal network resources. Which of the following is the MOST likely reason?

- A. Incorrect DNS
- B. Incorrect subnet mask
- C. Duplicate IP address
- D. Incorrect SSID

Answer: ([SHOW ANSWER](#))

NEW QUESTION: 337

Which of the following is used to provide hot standby capabilities using paired routers?

- A. L2TP
- B. ISAKMP
- C. CARP
- D. PPTP

Answer: C ([LEAVE A REPLY](#))

NEW QUESTION: 338

A flood disables the equipment in a company's server room. When implementing the disaster recovery plan, all operations are immediately transitioned to another location with momentary downtime. This is an example of a:

- A. warm site.
- B. hot site.
- C. snapshot.
- D. cold site.

Answer: ([SHOW ANSWER](#))

NEW QUESTION: 339

A device operating at Layer 3 of the OSI model uses which of the following protocols to determine the path to a different network?

- A. STP
- B. RTP
- C. RIP
- D. NTP
- E. SIP

Answer: C ([LEAVE A REPLY](#))

Section: (none)

NEW QUESTION: 340

You are tasked with creating a network that will accomplish the following requirements

Requirements:

- 1) The remote sales team must be able to connect to the corporate network
- 2) Each department must have ONLY two PCs and a server
- 3) Each department must be segmented from each other
- 4) The following VLANs have been designated:
 - a) VLAN 2- Finance
 - b) VLAN 12- Sales
 - c) VLAN 22- Human Resources (HR)

INSTRUCTIONS: Objects can be used multiple times and not all placeholders need to be filled. Complete the network by dragging the required objects into the diagram.

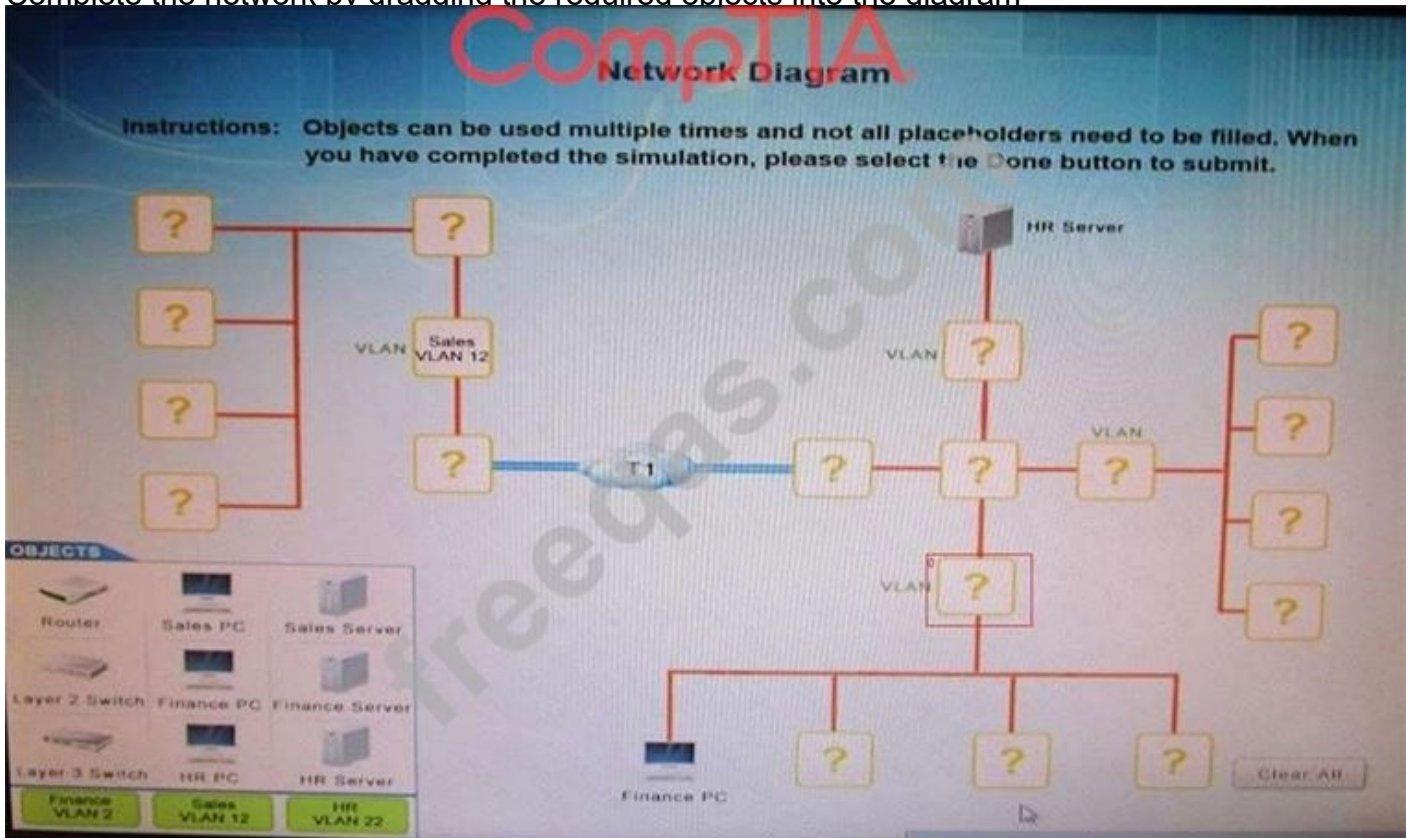

Answer:

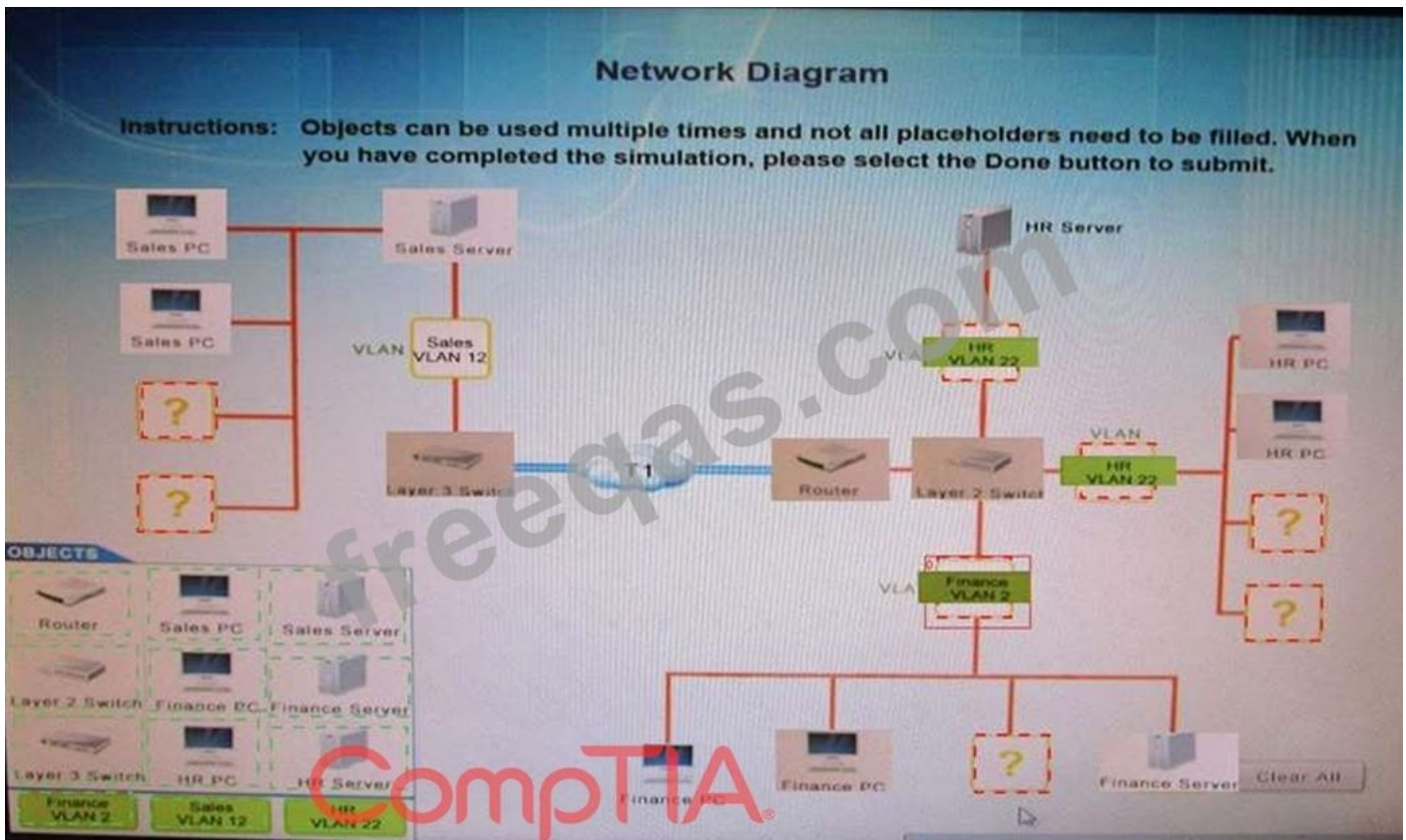

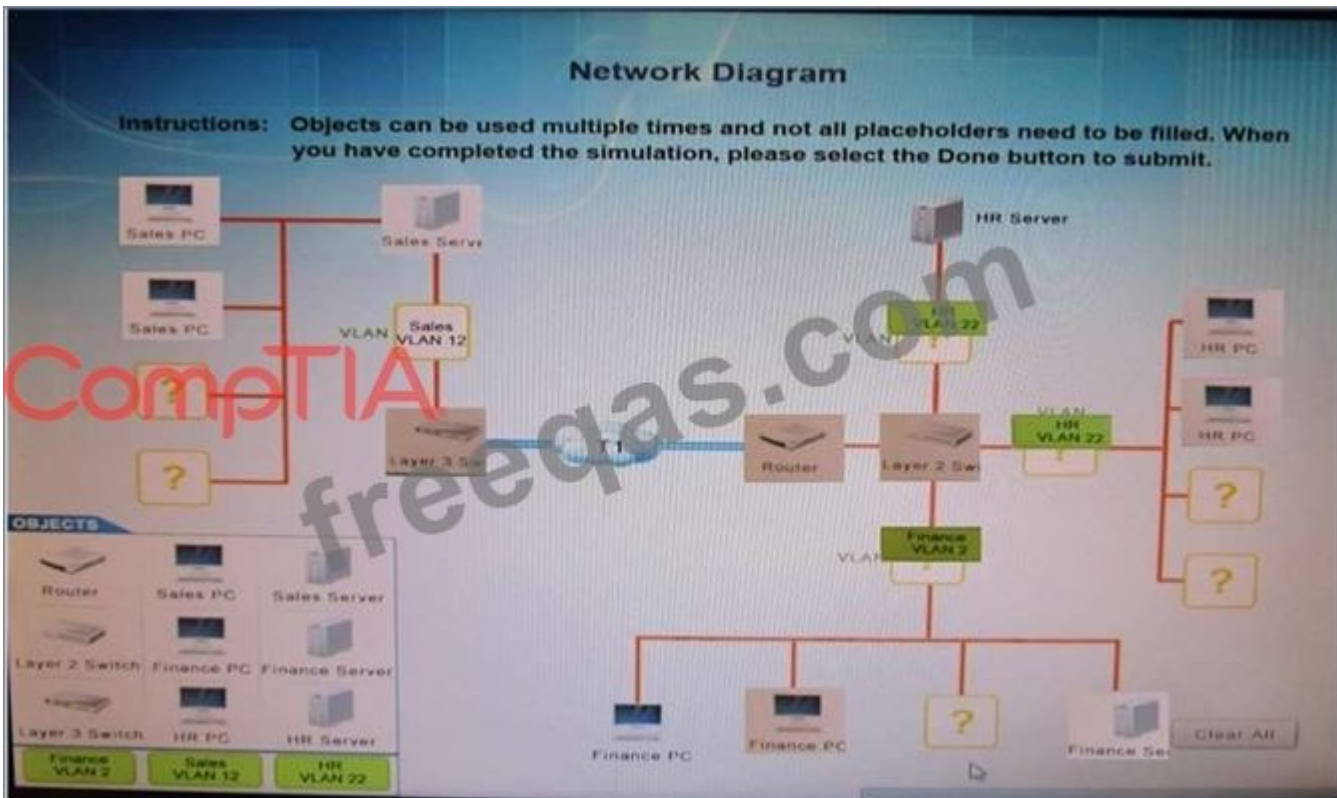

NEW QUESTION: 341

When deploying UTP cables in a networking environment, which of the following are acceptable standards?

(Choose two.)

- A. 10Base2
- B. 10Base5
- C. 10GBaseT
- D. 1000BaseLX
- E. 1000BaseSX
- F. 1000BaseT

Answer: ([SHOW ANSWER](#))

Explanation/Reference:

NEW QUESTION: 342

Which of the following solutions will detect and disable a rogue access point?

- A. IPS
- B. IDS
- C. Packet sniffer
- D. Port scan

Answer: ([SHOW ANSWER](#))

NEW QUESTION: 343

A Chief Information Officer (CIO) tasks the network engineer with protecting the network from

outside attacks. Placing which of the following devices on the network perimeter would provide the MOST security for the system?

- A. NGFW
- B. IDS/IPS
- C. Content filter
- D. Firewall

Answer: ([SHOW ANSWER](#))

NEW QUESTION: 344

A network technician is installing a new fiber-optic connection between two buildings on a campus network. When the network technician connects the fiber at the second location, the interface link light does not light up. Which of the following should the technician do NEXT?

- A. Check the duplex on each interface
- B. Reverse the fiber pair
- C. Install a fiber distribution panel
- D. Configure a media converter for each switch

Answer: A ([LEAVE A REPLY](#))

NEW QUESTION: 345

A technician has deployed an additional DHCP server for redundancy. Clients in certain subnets are not receiving DHCP leases from the new DHCP server. Which of the following is the MOST likely cause?

- A. The new DHCP server is not receiving the requests from the clients.
- B. The new DHCP server's IP address was not added to the router's IP helper list.
- C. The ARP cache of the new DHCP server needs to be updated.
- D. The ARP table on the router needs to be cleared.

Answer: B ([LEAVE A REPLY](#))

NEW QUESTION: 346

A junior network technician receives a help desk ticket from an end user who is having trouble accessing a web application that was working the previous day. After talking with the end user and gathering information about the issue, which of the following would be the most likely course of action for the technician to perform NEXT?

- A. Implement the solution.
- B. Escalate the ticket to a senior technician.
- C. Establish a theory of probable cause.
- D. Document the findings and outcomes.

Answer: ([SHOW ANSWER](#))

Valid N10-007 Dumps shared by PrepPdf.com for Helping Passing N10-007 Exam!
PrepPdf.com now offer the **newest N10-007 exam dumps**, the PrepPdf.com N10-007 exam **questions have been updated** and **answers have been corrected** get the **newest** PrepPdf.com N10-007 dumps with Test Engine here:
<https://www.preppdf.com/CompTIA/N10-007-prepaway-exam-dumps.html> (**690** Q&As Dumps, **40%OFF** Special Discount: **Exam-Tests**)

NEW QUESTION: 347

Which of the following manages the delegation of physical equipment to the virtual components?

- A. Virtual router
- B. Network card
- C. Hypervisor
- D. Virtual switch

Answer: C ([LEAVE A REPLY](#))

NEW QUESTION: 348

A network technician needs to address bandwidth issues on the wireless network. There are currently four

802.11n access points. The technician would like to increase the bandwidth. Which of the following would be the BEST solution?

- A. MIMO
- B. Increase the signal
- C. Channel bonding
- D. Disable SSID

Answer: C ([LEAVE A REPLY](#))

NEW QUESTION: 349

A technician is setting up a branch office on a point-to-point connection. Which of the following IP network blocks is the MOST efficient use of IP address space for the router connections between the two sites?

- A. /24
- B. /30
- C. /25
- D. /32

Answer: B ([LEAVE A REPLY](#))

NEW QUESTION: 350

A network engineer for a manufacturing company is implementing a wireless network that provides reliable coverage throughout the facility. There are several large, electric, motorized machines installed on the shop floor for automating the manufacturing process. These machines are known to be significant sources of RF interference. Which of the following frequencies should

the wireless network use to MINIMIZE this interference?

- A. 56MHz
- B. 900MHz
- C. 2.4 GHz
- D. 5GHz

Answer: D ([LEAVE A REPLY](#))

NEW QUESTION: 351

A network team at a large company has received funding for a WiFi refresh. One of the requirements in the RFP is the new WLAN infrastructure must provide APs that support multiple streams of information at the same time. For which of the following WiFi features is the network team looking?

- A. Automatic channel selection
- B. MIMO
- C. Channel bonding
- D. TDM
- E. MU-MIMO

Answer: E ([LEAVE A REPLY](#))

NEW QUESTION: 352

A network technician is attempting to update firmware on a router but cannot physically locate the router.

Which of the following would show where to locate router?

- A. Rack diagram
- B. Diagram symbols
- C. Logical diagram
- D. Port locations

Answer: A ([LEAVE A REPLY](#))

NEW QUESTION: 353

A system administrator receives reports from users of odd behavior in regard to a recently installed server.

While reviewing the server network configuration, the systems administrator does both a forward and a reverse DNS lookup on the host, along with the network adapter configuration.

```
$ nslookup server.company.com
server.company.com has address 129.168.0.100
server.company.com is handled by 100 mail.company.com
$ host 192.168.0.100
100.0.168.192.in-addr.arpa domain name pointer web.company.com
$ host web.company.com
server.company.com has address 129.168.0.50
server.company.com is handled by 100 mail.company.com
$ ifconfig -a
eth0Link encap:Ethernet HWaddr 00:30:48:9D:06:73
Inet addr:192.168.0.100 Bcast:192.168.0.255 Mask:255.255.255.0
UP BROADCAST RUNNING MULTICAST MTU:1500 Metric:1
lo0Link encap:Local Loopback
inet addr:127.0.0.1 Mask:255.0.0.0
UP LOOPBACK RUNNING MTU:16436 Metric:1
```

Which of the following is the problem identified in the output above?

- A. The server IP address is incorrectly configured.
- B. The DNS lookup entry is incorrectly configured.
- C. There is no reverse DNS entry for this host.
- D. The reverse DNS entry is pointing to a different host.

Answer: ([SHOW ANSWER](#))

NEW QUESTION: 354

A second router was installed on a network to be used as a backup for the primary router that works as a gateway. The infrastructure team does not want to change the IP address of the gateway on the devices. Which of the following network components should be used in this scenario?

- A. Virtual IP
- B. Reserved IP
- C. Loopback IP
- D. Public

Answer: C ([LEAVE A REPLY](#))

NEW QUESTION: 355

A technician purchasing equipment for a company has determined that several new employees will require new wired workstations. Which of the following is the network technician likely to recommend to add the employees to the existing infrastructure?

- A. Switch
- B. Hub
- C. WAP
- D. Bridge

Answer: ([SHOW ANSWER](#))

NEW QUESTION: 356

A system administrator receives report from users of odd behavior in regard to recently installed server. While reviewing the server network configuration, the systems administrator does both a forward and a reverse DNS lookup on the host, along with the network adapter configuration.

```
$ host server.company.com
server.company.com has address 129.168.0.100
server.company.com is handled by 100 mail.company.com
$ host 192.168.0.100
100.0.168.192.in-addr.arpa domain name pointer web.company.com
$ host web.company.com
server.company.com has address 129.168.0.50
server.company.com is handled by 100 mail.company.com
$ ifconfig -a
eth0Link encap:Ethernet HWaddr 00:30:48:9D:06:73
Inet addr:192.168.0.100 Bcast:192.168.0.255 Mask:255.255.255.0
UP BROADCAST RUNNING MULTICAST MTU:1500 Metric:1
lo0Link encap:Local Loopback
inet addr:127.0.0.1 Mask:255.0.0.0
UP LOOPBACK RUNNING MTU:16436 Metric:1
```

Which of the following is the problem identified in the output above?

- A. The DNS lookup entry is incorrectly configured.
- B. The reverse DNS entry is pointing to a different host.
- C. There is no reverse DNS entry for this host.
- D. The server IP address is incorrectly configured.

Answer: A (LEAVE A REPLY)

NEW QUESTION: 357

A user at a hotel sees two SSIDs; both are called "HotelWireless". After the PC connects to one of the APs, the user notices their browser homepage has been changed. Which of the following BEST describes this AP?

- A. DDoS
- B. War driving
- C. Man-in-the-middle
- D. Evil twin

Answer: D (LEAVE A REPLY)

NEW QUESTION: 358

The security department is looking to install a new IP-based camera. Plugging the camera into the available Ethernet jack does not power on the camera. Upon further investigation, the cable tests fine, and it does provide power to a VoIP phone. Which of the following is MOST likely causing the issue?

- A. The camera requires Cat 7 cabling.
- B. The brown pair UTP has a short.
- C. The camera requires 802.3at power
- D. The switchport has PoE disabled.

Answer: A ([LEAVE A REPLY](#))

NEW QUESTION: 359

A network administrator configures a router with the following IP address information:

Gigabit Ethernet 1 Interface: 10.10.0.1/24

Serial 0 Interface: 10.10.0.253/30

Clients are connected to a switch on the gigabit Ethernet interface; the ISP is connected to the Serial 0 interface.

When the router configuration is complete and client devices are reconfigured, all clients report that they are unable to connect to the Internet.

Which of the following is the MOST likely reason?

- A. The router was configured with an incorrect subnet mask
- B. The router was configured with an incorrect loopback address
- C. The router was configured with an incorrect IP address
- D. The router was configured with an incorrect default gateway

Answer: A ([LEAVE A REPLY](#))

NEW QUESTION: 360

A network administrator has had difficulty keeping track of IP address assignments on networking devices

and clients recently. Which of the following is the BEST technology to aid in this scenario?

- A. DHCP
- B. DNS
- C. IPAM
- D. NTP

Answer: C ([LEAVE A REPLY](#))

NEW QUESTION: 361

A network administrator wants to ensure devices on the network are not susceptible to published exploits.

Which of the following will the administrator MOST likely conduct?

- A. A packet analysis
- B. A vulnerability scan
- C. A network log review
- D. A port scan

Answer: C ([LEAVE A REPLY](#))

Valid N10-007 Dumps shared by PrepPdf.com for Helping Passing N10-007 Exam!
PrepPdf.com now offer the **newest N10-007 exam dumps**, the PrepPdf.com N10-007 exam **questions have been updated** and **answers have been corrected** get the **newest** PrepPdf.com N10-007 dumps with Test Engine here:
<https://www.preppdf.com/CompTIA/N10-007-prepaway-exam-dumps.html> (690 Q&As Dumps, **40%OFF Special Discount: Exam-Tests**)

NEW QUESTION: 362

A technician has installed a Linux server in the tax office. The server can access most of the resources on the network, but it cannot connect to another server that has a share for backup. The technician learns that the target server is on a different subnet. Which of the following tools should the technician use to ensure the Linux server can reach the backup location?

- A. netstat
- B. traceroute
- C. route
- D. dig
- E. ifconfig

Answer: ([SHOW ANSWER](#))

Explanation/Reference:

NEW QUESTION: 363

A technician is allocating the IP address space needed for a new remote office. This office will contain the engineering staff with six employees and the digital marketing staff with 55 employees. The technician has decided to allocate the 192.168.1.0/24 block to the remote office. The engineering staff has been allocated the 192.168.1.64/29 subnet. Using the LEAST amount of space possible, which of the following would be the last usable IP address in the engineering subnet?

- A. 192.168.1.62
- B. 192.168.1.70
- C. 192.168.1.71
- D. 192.168.1.63

Answer: ([SHOW ANSWER](#))

NEW QUESTION: 364

A Chief Information Officer (CIO) is reviewing a proposal to provide access security for the IT department's restricted area. Which of the following is a preventive measure that should be implemented?

- A. Asset tags
- B. Biometric lock
- C. Cameras
- D. Motion detection

Answer: B ([LEAVE A REPLY](#))

NEW QUESTION: 365

Which of the following technologies is used to attach multiple guest operating systems to a single physical network port?

- A. vSAN
- B. Fibre Channel
- C. FCoE
- D. Virtual switch
- E. VPC

Answer: D ([LEAVE A REPLY](#))

NEW QUESTION: 366

Joe, a technician, was able to copy data at a site with no network equipment between two new laptops, featuring gigabit Ethernet ports, by using a regular straight-through patch cable. Joe then unsuccessfully tried to accomplish the same thing at a different site from his laptop with a gigabit Ethernet port to an older customer unit, which had a 10/100 network port. Which of the following is the cause of this?

- A. The customer's laptop does not support auto-MDIX.
- B. Joe's laptop does not support auto-MDIX.
- C. Straight-through patch cables are prone to crosstalk.
- D. The customer's laptop NIC does not support full duplex.

Answer: A ([LEAVE A REPLY](#))

NEW QUESTION: 367

At which of the following OSI model layers would a router operate?

- A. Physical
- B. Network
- C. Transport
- D. Data link

Answer: B ([LEAVE A REPLY](#))

Explanation/Reference:

NEW QUESTION: 368

Which of the following is the MOST economical way for Sandy, a technician, to implement 10- Gigabit Ethernet at a datacenter?

- A. 10GBaseSR
- B. 10GBaseX
- C. 10GBaseLR
- D. 10GBaseT

Answer: ([SHOW ANSWER](#))

NEW QUESTION: 369

An employee, who is using a laptop connected to the wireless network. Is able to connect to the Internet but not to internal company resources. A systems administrator reviews the following information from the laptop:

```
IP: 192.168.1.100
MASK: 255.255.255.0
ROUTER: 192.168.1.1
```

The administrator was expecting to see a network address within 10.100.0.0/23, which is consistent with the company's wireless network. The network administrator verifies the company's wireless network is configured and working properly. Which of the following is the MOST likely cause of this issue?

- A. Interference
- B. channel overlap
- C. Security type mismatch
- D. Wrong SSID

Answer: B ([LEAVE A REPLY](#))

NEW QUESTION: 370

A network administrator is installing the company first external-facing web server and examining where to place it on the network. In which of the following zones should the server be configured?

- A. WAN
- B. LAN
- C. VPN
- D. VLAN
- E. DMZ

Answer: (SHOW ANSWER)

NEW QUESTION: 371

Which of the following allows for file-level network storage?

- A. SAN
- B. iSCSI
- C. FCoE
- D. NAS

Answer: D ([LEAVE A REPLY](#))

Explanation

NEW QUESTION: 372

A technician is setting up a direct connection between two older PCs so they can communicate but not be on the corporate network. The technician does not have access to a spare switch but does have spare Cat

6 cables, RJ-45 plugs, and a crimping tool. The technician cuts off one end of the cable. Which of the following should the technician do to make a crossover cable before crimping the new plug?

- A. Reverse the wires leading to pins 1 and 3
- B. Reverse the wires leading to pins 2 and 4
- C. Reverse the wires leading to pins 2 and 3
- D. Reverse the wires leading to pins 1 and 2

Answer: B ([LEAVE A REPLY](#))

NEW QUESTION: 373

A network administrator is testing connectivity at a new corporate site. The site has a wireless guest as well as a wired employee network. After verifying connectivity, the administrator checks link speeds by using a speed testing website. The speed testing website shows lower download and upload speeds for the wired network than the wireless network. Which of the following is the MOST likely explanation?

- A. There is less local congestion on the wireless network
- B. The testing server for the wired network was farther away
- C. The firewall is configured to throttle traffic to specific websites
- D. The wireless access points were misconfigured

Answer: ([SHOW ANSWER](#)**)**

Explanation/Reference:

NEW QUESTION: 374

Which of the following is used to assign an IP address to a device?

- A. DNS
- B. RADIUS
- C. NTP
- D. DHCP

Answer: D ([LEAVE A REPLY](#))

NEW QUESTION: 375

After a server outage, a technician discovers that a physically damaged fiber cable appears to be the problem. After replacing the cable, the server will still not connect to the network. Upon inspecting the cable at the server end, the technician discovers light can be seen through one of the two fiber strands.

Which of the following should the technician do FIRST to reconnect the server to the network?

- A. Replace the server's single-mode fiber cable with multimode fiber
- B. Use a TDR to test both strands of a new replacement cable prior to connecting it to the server
- C. Move the fiber cable to different port on the switch where both strands function
- D. Reverse the fiber strands of the cable and reconnect them to the server

Answer: D ([LEAVE A REPLY](#))

NEW QUESTION: 376

Zach, a technician, is installing an 802.11n network. Which of the following should he disable to stop broadcasting the network name?

- A. WEP
- B. Channel
- C. SSID
- D. WPA

Answer: C ([LEAVE A REPLY](#))

Valid N10-007 Dumps shared by PrepPdf.com for Helping Passing N10-007 Exam!
PrepPdf.com now offer the **newest N10-007 exam dumps**, the PrepPdf.com N10-007 exam **questions have been updated** and **answers have been corrected** get the **newest** PrepPdf.com N10-007 dumps with Test Engine here:
<https://www.preppdf.com/CompTIA/N10-007-prepaway-exam-dumps.html> (**690** Q&As Dumps, **40%OFF** Special Discount: **Exam-Tests**)

NEW QUESTION: 377

Which of the following is the MOST economical way for Sandy, a technician, to implement 10-Gigabit Ethernet at a datacenter?

- A. 10GBaseLR
- B. 10GBaseT
- C. 10GBaseX
- D. 10GBaseSR

Answer: ([SHOW ANSWER](#))

NEW QUESTION: 378

Hotspot Question

Corporate headquarters provided your office a portion of their class B subnet to use at a new office location.

Range Given: 172.30.232.0/24

Sales 57 devices

▪
HR 23 devices

▪
IT 12 devices

▪
Finance 32 devices

▪
Marketing 9 devices

▪
INSTRUCTIONS

Allocate the minimum number of addresses (using CIDR notation) needed to accommodate each department.

After accommodating each department, identify the unused portion of the subnet by responding to the question on the graphic.

All drop downs must be filled.

If at any time you would like to bring back the initial state of the simulation, please click the Reset

All button.

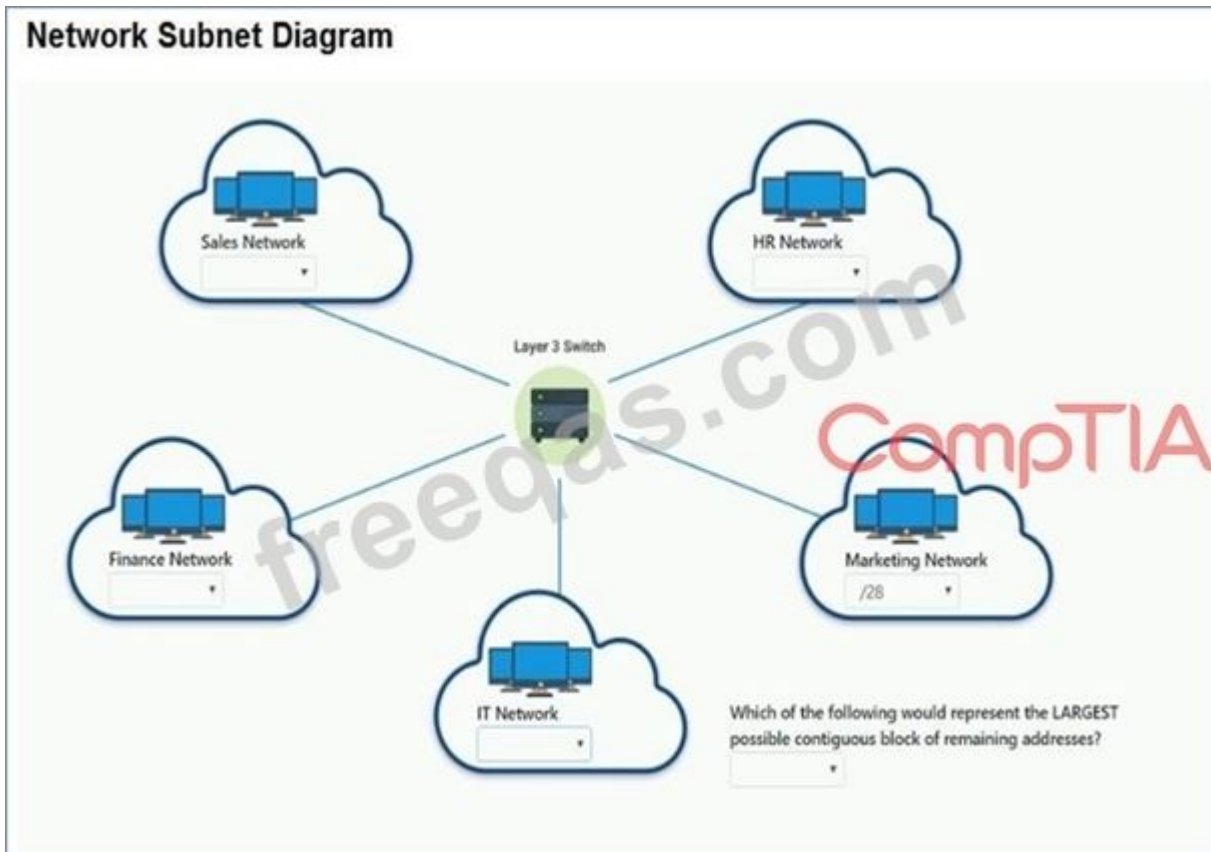

CompTIA

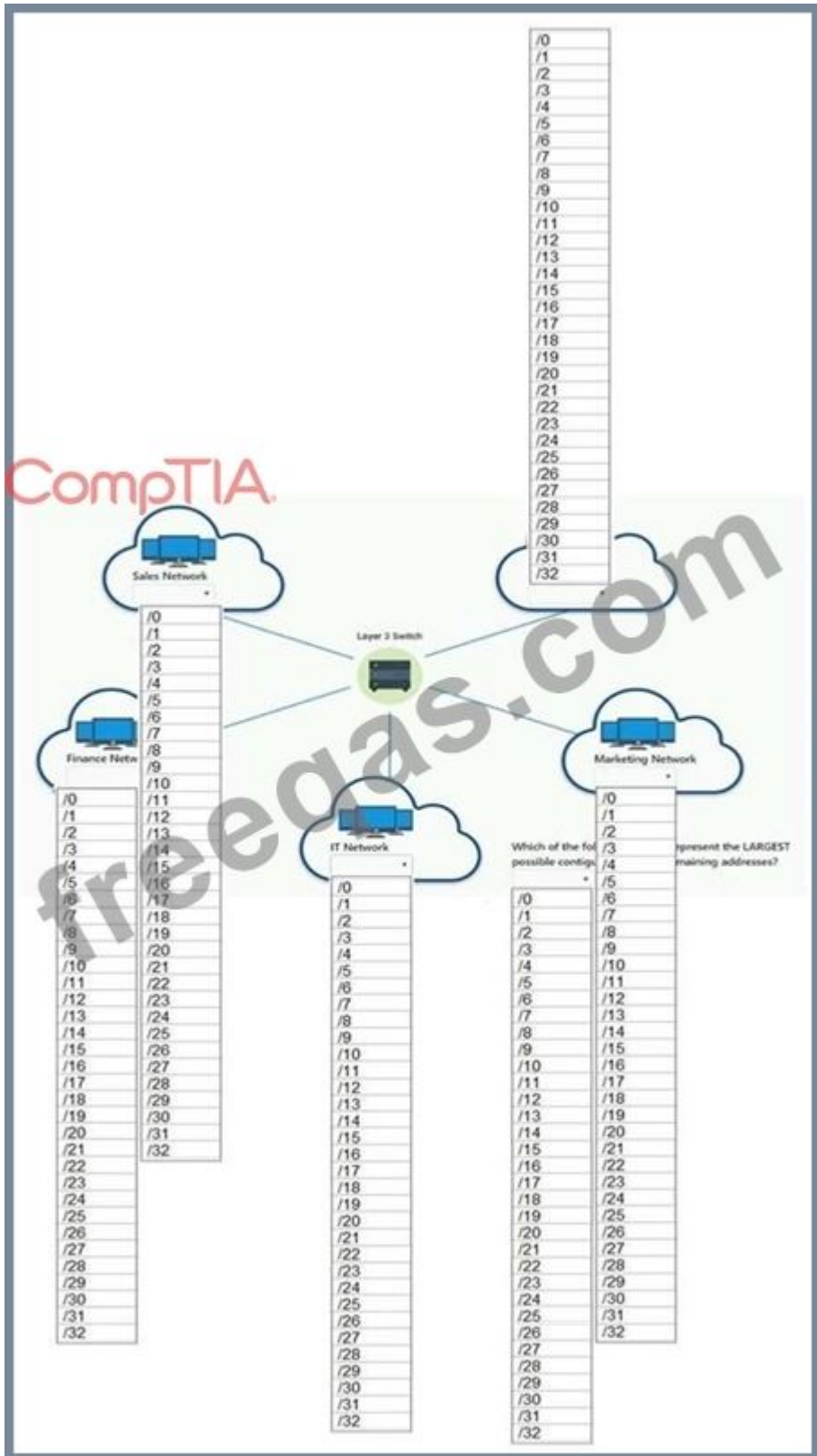

Answer:

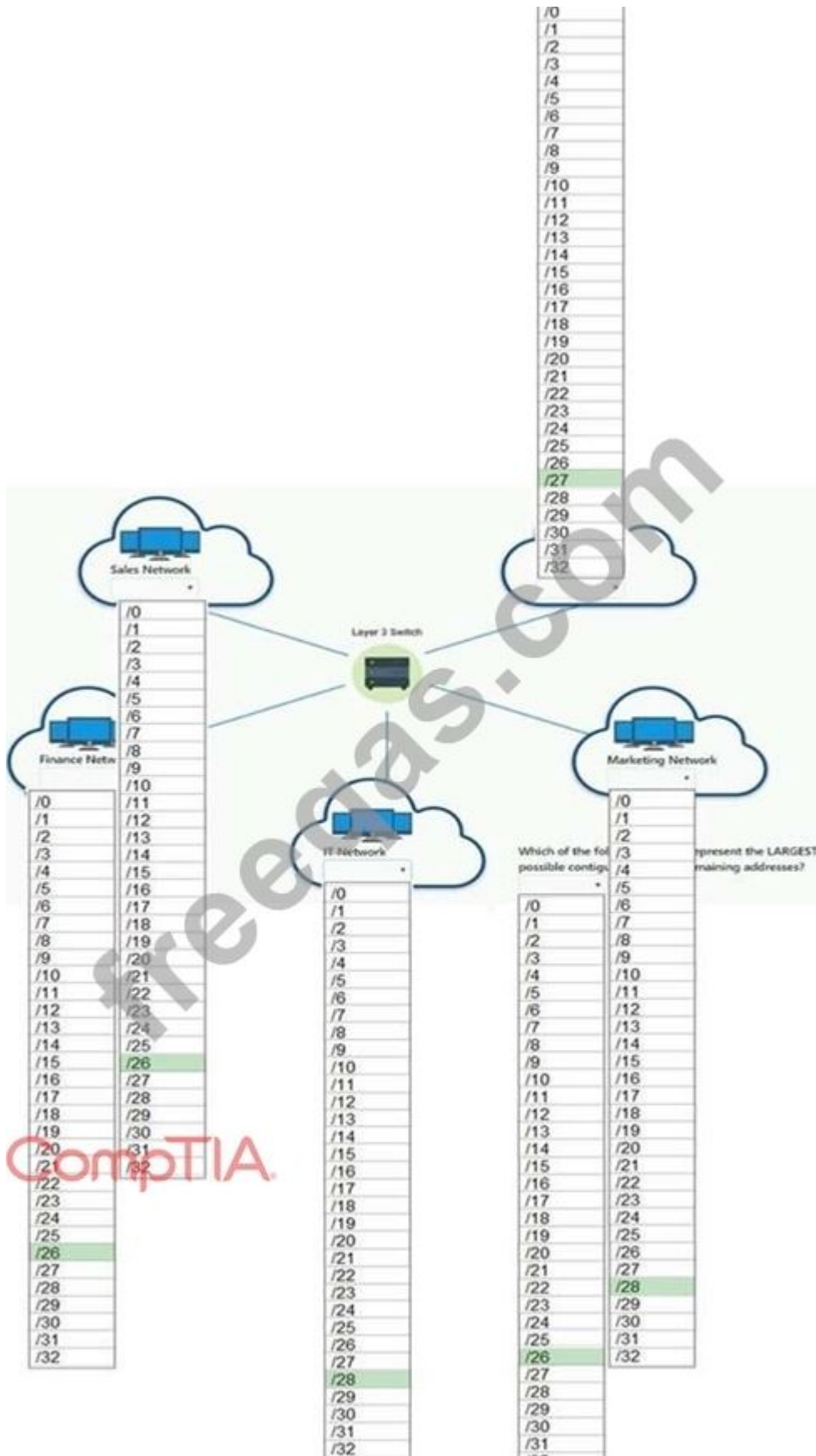

NEW QUESTION: 379

Which of the following components can be used to manage network traffic to all nodes in a hypervisor?

- A. Virtual NIC

- B. Multilayer switch
- C. Load balancer
- D. Media converter
- E. Virtual switch

Answer: ([SHOW ANSWER](#))

NEW QUESTION: 380

A technician wants to deploy a network that will require wireless client devices to prompt for a username and password before granting access to be the wireless network. Which of the following must be configured to implement this solution?

- A. CCMP-AES
- B. EAP-PEAP
- C. WPA2-PSK
- D. TKIP-RC4

Answer: ([SHOW ANSWER](#))

NEW QUESTION: 381

Which of the following networking devices operates at Layer1?

- A. Router
- B. Bridge
- C. Firewall
- D. Hub

Answer: ([SHOW ANSWER](#))

NEW QUESTION: 382

A network technician has configured a new firewall to allow TCP port 80 traffic and deny UDP traffic. Users have reported that they are unable to access Internet websites.

The technician verifies by attempting to access a popular website. Which of the following will MOST likely correct the error?

- A. UDP port 53 needs to be allowed
- B. HTTP uses UDP
- C. HTTP needs port 443 allowed
- D. DNS port 23 needs to be allowed

Answer: A ([LEAVE A REPLY](#))

NEW QUESTION: 383

A customer wants to be able to separate traffic on a local network without using a router. Which of the following should a technician install?

- A. A load balancer
- B. A VPN concentrator
- C. A UTM appliance

- D. A multilayer switch
- E. A wireless controller

Answer: D ([LEAVE A REPLY](#))

NEW QUESTION: 384

A firewall administrator is implementing a rule that directs HTTP traffic to an internal server listening on a non-standard socket. Which of the following types of rules is the administrator implementing?

- A. NAT
- B. STP
- C. PAT
- D. ARP
- E. SNAT

Answer: ([SHOW ANSWER](#))

NEW QUESTION: 385

A small business developed an in-house application that is very sensitive to network latency when a communicating between servers. Due to a lack of funds, the business had to build its own network for workstations and servers. Now a network administrator must redesign the network due to performance issues with the application. Which of the following would be the MOST cost effective for the administrator to recommend?

- A. Install Fibre Channel for the server network
- B. Create Ethernet VLANs
- C. Disable autonegotiation on the servers
- D. Install 10Gb Ethernet NICs in the servers

Answer: D ([LEAVE A REPLY](#))

NEW QUESTION: 386

A customer cannot access a company's secure website. The company's network security is reviewing the firewall for the server and finds the following output:

Time	Action	Src IP	Src Port	Dst IP	Dst Port
0902	Allow	12.73.15.5	31865	10.5.0.10	80
1005	Deny	12.73.15.5	31866	10.5.0.10	443
1006	Deny	12.73.15.5	31890	10.5.0.10	443

Which of the following changes should be made to allow all customers to access the company's secure website?

- A. Allow any any 10.5.0.10 443
- B. Allow any any 12.73.15.5 443

C. Allow 10.5.0.10 443 any any

D. Allow 10.5.0.10 any 10.5.0.10 80

Answer: C ([LEAVE A REPLY](#))

Explanation

NEW QUESTION: 387

A user reports network resources can no longer be accessed. The PC reports a link but will only accept static IP addresses. The technician pings other devices on the subnet, but the PC displays the message . Which of the following are MOST likely the causes of this issue? (Select Destination unreachable TWO).

A. VLAN mismatch

B. Crosstalk

C. Bent pins

D. TX/RX reverse

E. Damaged cables

F. Duplex mismatch

Answer: A,C ([LEAVE A REPLY](#))

NEW QUESTION: 388

A technician is downloading an ISO from a vendor's website. To ensure the integrity of the download, which of the following should be verified?

A. Vendor URL

B. Encryption

C. File hashing

D. File size

Answer: C ([LEAVE A REPLY](#))

NEW QUESTION: 389

You have been tasked with testing a CAT5e cable. A summary of the test results can be found on the screen.

Step 1: Select the tool that was used to create the cable test results.

Step 2: Interpret the test results and select the option that explains the results. After you are done with your analysis, click the 'Submit Cable Test Analysis' button.

Cable Crimp

Instructions: You have determined that the original crimp is faulty using the T568B cabling standard. Drag the appropriate crimp tool to the RJ-45 connector. When you are finished, click the Done button.

Question

You have been tasked with testing a CAT5e cable. A summary of the test results can be found on the screen.

Step 1: Select the tool that was used to create the cable test results.

Step 2: Interpret the test results and select the option that explains the results. After you are done with your analysis, click the 'Submit Cable Test Analysis' button.

Done

Reset

Help

This window can be resized.

ATA Simulation

RJ-45 Connector



Reset Cable

Cable Test

Step 1: Select the tool that was used to create the cable test results.

Cable Test Result		
1, 2	Open	7ft
3, 6	Short	7ft
4, 5	Open	7ft
7, 8	Open	7ft



Tool Choices	
<input type="checkbox"/>	Crimper
<input type="checkbox"/>	Cable Certifier
<input type="checkbox"/>	Multimeter
<input type="checkbox"/>	Punch Down Tool
<input type="checkbox"/>	Protocol Analyzer
<input type="checkbox"/>	OTDR
<input type="checkbox"/>	Toner Probe

CompTIA

Answer:

Cable Test

Step 1: Select the tool that was used to create the cable test results.

The screenshot shows a software interface with two main components. On the left is a table titled 'Cable Test Result' with four rows of data. On the right is a list titled 'Tool Choices' with seven items, each with a checkbox. An arrow points from the table to the list, indicating that the tool used for the test results is being selected.

Pair	Condition	Length
1, 2	Open	7ft
3, 6	Short	7ft
4, 5	Open	7ft
7, 8	Open	7ft

- Crimper
- Cable Certifier
- Multimeter
- Punch Down Tool
- Protocol Analyzer
- OTDR
- Toner Probe

CompTIA®

Explanation

Cable Test

Step 1: Select the tool that was used to create the cable test results.

Cable Test Result			
1, 2	Open	7ft	
3, 6	Short	7ft	
4, 5	Open	7ft	
7, 8	Open	7ft	

Tool Choices

Crimper

Cable Certifier

Multimeter

Punch Down Tool

Protocol Analyzer

OTDR

Toner Probe

Step 2: Interpret the test results and select the option that explains the results.
 After you are done with your analysis, click the 'Submit Cable Test Analysis' button.

Correctly crimped cable
 Incorrectly crimped cable

CompTIA

A Cable Certifier provides "Pass" or "Fail" information in accordance with industry standards but can also show detailed information when a "Fail" occurs. This includes shorts, the wire pairs involved and the distance to the short. When a short is identified, at the full length of the cable it means the cable has not been crimped correctly.

NEW QUESTION: 390

Which of the following physical security devices is used to detect unauthorized server room access?

- A. Access badge
- B. Biometrics
- C. Smart card
- D. Video surveillance

Answer: (SHOW ANSWER)

Explanation

NEW QUESTION: 391

A network security technician observes multiple attempts to scan network hosts and devices. All the attempts originate from a single host on the network. Which of the following threats is MOST likely involved?

- A. Smurf attack
- B. Rogue AP
- C. Compromised system
- D. Unintentional DoS

Answer: ([SHOW ANSWER](#))

Section: (none)

Valid N10-007 Dumps shared by PrepPdf.com for Helping Passing N10-007 Exam!
PrepPdf.com now offer the **newest N10-007 exam dumps**, the PrepPdf.com N10-007 exam **questions have been updated** and **answers have been corrected** get the **newest** PrepPdf.com N10-007 dumps with Test Engine here:
<https://www.preppdf.com/CompTIA/N10-007-prepaway-exam-dumps.html> (690 Q&As Dumps, **40%OFF Special Discount: Exam-Tests**)

NEW QUESTION: 392

A home user is unable to get to the Internet from a workstation that is connected to a wireless network.

When reviewing the results of the ipconfig command, the user wants to verify the default gateway is correct. Which of the following devices should be the gateway?

- A. Cable modem
- B. Layer 2 switch
- C. DNS server
- D. SOHO router

Answer: A ([LEAVE A REPLY](#))

NEW QUESTION: 393

Which of the following occurs when antenna gain is increased on an access point?

- A. Cell size increases
- B. Throughput decreases
- C. Attenuation increases
- D. Connection speeds decrease

Answer: A ([LEAVE A REPLY](#))

NEW QUESTION: 394

A client requests a new dynamic address and receives a response from two DHCP servers.

Which of the following addressing information would the client use?

- A. The IP addressing information received first
- B. The IP addressing information from the highest server IP address
- C. The IP addressing information from the highest server MAC address

D. The IP addressing information received last

Answer: ([SHOW ANSWER](#))

NEW QUESTION: 395

Joe, an employee at a large regional bank, wants to receive company email on his personal smartphone and tablet. To authenticate on the mail server, he must first install a custom security application on those mobile services.

Which of the following policies would BEST enforce this requirement?

- A. Incident response policy
- B. DLP policy
- C. Remote access policy
- D. BYOD policy

Answer: A ([LEAVE A REPLY](#))

NEW QUESTION: 396

A company runs Linux servers in its own datacenter and also on a popular public cloud service provider. The servers hosted by the cloud provider can only be accessed with proper authorization and are only accessed by the company's datacenter. Which of the following BEST describes the type of cloud architecture being used? (Select TWO).

- A. Hybrid
- B. IaaS
- C. SaaS
- D. Public
- E. PaaS
- F. Private

Answer: A,F ([LEAVE A REPLY](#))

NEW QUESTION: 397

You have been tasked with testing a CAT5e cable. A summary of the test results can be found on the screen.

Instructions

Step 1: Select the tool that was used to create the cable test results.

Step 2: Interpret the test results and select the option that explains the results. After you are done with your analysis, click the 'Submit' button.

If at any time you would like to bring back the initial state of the simulation, please click the Reset All button.

Answer Area

Step 1 Select the tool that was used to create the cable test results

	▼
Cable Certifier	
Punch Down Tool	
Crimper	
Toner Probe	
OTDR	
Multimeter	
Protocol Analyzer	

Step 2 Interpret the test results and select the option that explains the results

	▼
Correctly crimped cable	
Incorrectly crimped cable	

Answer:

Answer Area

Step 1 Select the tool that was used to create the cable test results

	▼
Cable Certifier	
Punch Down Tool	
Crimper	
Toner Probe	
OTDR	
Multimeter	
Protocol Analyzer	

Step 2 Interpret the test results and select the option that explains the results

	▼
Correctly crimped cable	
Incorrectly crimped cable	

NEW QUESTION: 398

A network technician needs to install a new access switch. After installing the new switch, the technician begins to move connections from the old switch to the new switch. The old switch used a GBIC connectors, and the new switch uses an SEF LC with LC connectors. After connecting the SC connector to the SC-to-LC adapter and plugging it to the switch, the link does not come up as expected. Which of the following should a network technician perform NEXT?

- A. Replace SEP with a new one.
- B. Replace multimode with single-mode cable
- C. Transpose the fiber pairs.
- D. Fall back to the switch.

Answer: B (LEAVE A REPLY)

NEW QUESTION: 399

A network administrator gets a call regarding intermittent network outages across the country. Which of the following should be used to connect to the network so the administrator can troubleshoot this issue from home? (Choose two.)

- A. VPN
- B. SNMP
- C. FTP
- D. SSH
- E. SMTP

Answer: ([SHOW ANSWER](#))

NEW QUESTION: 400

A network administrator is going to be performing a major upgrade to the network. Which of the following should the administrator use in case of a failure?

- A. Baseline report
- B. Vulnerability report
- C. Business continuity plan
- D. Rollback plan

Answer: D ([LEAVE A REPLY](#))

NEW QUESTION: 401

Users have been experiencing slow network response times, and management has asked the network technician to provide evidence of network improvement. After optimizing the network, which of the following would be required?

- A. Physical diagram
- B. Performance baseline
- C. Change management
- D. IDF/MDF documentation

Answer: B ([LEAVE A REPLY](#))

NEW QUESTION: 402

A technician discovers that multiple switches require a major update. Which of the following policies should be followed?

- A. Change management policy
- B. Remote access policy
- C. Acceptable use policy
- D. Memorandum of understanding

Answer: A ([LEAVE A REPLY](#))

Explanation/Reference:

NEW QUESTION: 403

A junior technician is settings up a voice control device so the Chief Executive Officer (CEO) will

able to control various things in the office. Of which of the following types of the IoT technologies is this an example?

- A. WAN
- B. LAN
- C. SAN
- D. PAN

Answer: ([SHOW ANSWER](#))

NEW QUESTION: 404

A network technician receives a report that the company's intranet web server is not responding. The technician verifies successful connectivity to the server via the ping and tracert commands. The technician also verifies the routers and switches are online and operational, and then runs Telnet to port 80 and receives a response. Which of the following troubleshooting steps should the technician perform NEXT?

- A. Establish a plan to reset the company router.
- B. Report that an issue was not identified.
- C. Duplicate the issue and continue testing.
- D. Escalate the issue to the server administrator.

Answer: ([SHOW ANSWER](#))

NEW QUESTION: 405

Which of the following is the correct port number for NTP?

- A. 25
- B. 123
- C. 161
- D. 69

Answer: B ([LEAVE A REPLY](#))

NEW QUESTION: 406

Ann, a technician, installs a wireless router in a network closet in a large office. She then configures all workstations in various offices on that floor to use the wireless connection. Maximum connection speed at each workstation is 54 Mbps. Some users complain that their network connection is very slow. Which of the following is MOST likely the problem?

- A. Users with a slow connection are too far away from the wireless router.
- B. Users that cannot connect are configured on the wrong channel.
- C. Workstations were configured with the wrong connection speed on the wireless adapter.
- D. Wireless network SSID is incorrect.

Answer: A ([LEAVE A REPLY](#))

Valid N10-007 Dumps shared by PrepPdf.com for Helping Passing N10-007 Exam!
PrepPdf.com now offer the **newest N10-007 exam dumps**, the PrepPdf.com N10-007 exam **questions have been updated** and **answers have been corrected** get the **newest** PrepPdf.com N10-007 dumps with Test Engine here:
<https://www.preppdf.com/CompTIA/N10-007-prepaway-exam-dumps.html> (690 Q&As Dumps, **40%OFF Special Discount: Exam-Tests**)

NEW QUESTION: 407

Which of the following wireless connection types utilize MIMO on non-overlapping channels?
(Choose two.)

- A. 802.11g
- B. 802.11n
- C. 802.11b
- D. 802.11a
- E. 802.11ac

Answer: B,E ([LEAVE A REPLY](#))

NEW QUESTION: 408

A network technician notices that most of the nodes in the 10.10.74.0/23 address space return either 1 or 2 node hop after running a tracert, however, some of the new servers are showing a hop count larger than 10. Which of the following is the MOST likely reason for this?

- A. Those servers have host-based firewalls.
- B. New servers are being provisioned in the cloud.
- C. Some of the servers are configured to use different gateways.
- D. Part of the subnet is configured to use different VLANs.

Answer: B ([LEAVE A REPLY](#))

NEW QUESTION: 409

A network technician is setting up a new router. Since it is exposed to the public, which of the following are the BEST steps the technician should take when setting up this device? (Choose two.)

- A. Upgrade to the latest firmware.
- B. Enable encryption.
- C. Disable the console port.
- D. Disable unnecessary services.
- E. Allow remote management access.
- F. Use private IP addresses.

Answer: A,D ([LEAVE A REPLY](#))

NEW QUESTION: 410

A network technician notices that switches of the same model have different commands and

security features while administering them. Which of the following hardening techniques should the technician perform on a regular schedule to ensure all switches have the same features and security functionality?

- A. Verify the firmware file hash.
- B. Change the default credentials.
- C. Disable unused switchports.
- D. Apply patches and updates.

Answer: ([SHOW ANSWER](#))

NEW QUESTION: 411

Which of the following are characteristics of jumbo frames? (Choose two.)

- A. MTU size greater than 10000
- B. MTU size greater than 1500
- C. Commonly used on IaaS
- D. MTU size greater than 12000
- E. Commonly used on SAN

Answer: B,E ([LEAVE A REPLY](#))

NEW QUESTION: 412

A user is unable to connect to a server in another building. A technician is troubleshooting the issue and determines the following:

- 1) Client PC 1 has an IP address of 192.168.10.25/25
- 2) PC 1 can successfully ping its gateway of 192.168.10.1/25 which is an interface of router A
- 3) Server A is named 'BLDGBFILESVR01' and has an IP address of 192.168.10.145/25
- 4) PC 2 with an IP address of 192.168.10.200/25 can successfully ping server A

However, when PC 1 pings server A, it receives a destination host unreachable response. Which of the following is the MOST likely cause?

- A. Link from router A to PC 1 are on different subnets
- B. Link from server A to PC 2 is down
- C. Link from router A to server A is down
- D. Link from PC 1 to router A has duplex issues

Answer: A ([LEAVE A REPLY](#))

NEW QUESTION: 413

You have been tasked with testing a CAT5e cable. A summary of the test results can be found on the screen.

Instructions

Step 1: Select the tool that was used to create the cable test results.

Step 2: Interpret the test results and select the option that explains the results. After you are done with your analysis, click the 'Submit' button.

If at any time you would like to bring back the initial state of the simulation, please click the Reset All button.

Answer Area

Step 1 Select the tool that was used to create the cable test results

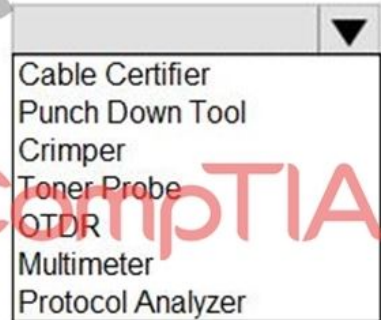

A dropdown menu with a downward arrow on the right. The menu is open, showing a list of tools: Cable Certifier, Punch Down Tool, Crimper, Toner Probe, OTDR, Multimeter, and Protocol Analyzer.

Step 2 Interpret the test results and select the option that explains the results

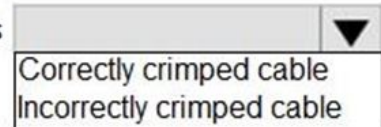

A dropdown menu with a downward arrow on the right. The menu is open, showing two options: Correctly crimped cable and Incorrectly crimped cable.

Answer:

Answer Area

Step 1 Select the tool that was used to create the cable test results

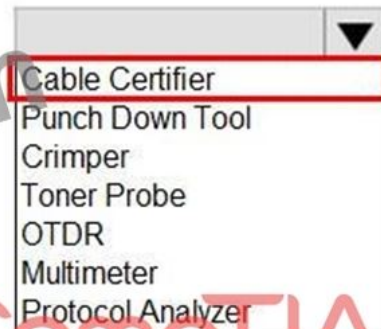

A dropdown menu with a downward arrow on the right. The menu is open, showing a list of tools: Cable Certifier, Punch Down Tool, Crimper, Toner Probe, OTDR, Multimeter, and Protocol Analyzer. The 'Cable Certifier' option is highlighted with a red border.

Step 2 Interpret the test results and select the option that explains the results



A dropdown menu with a downward arrow on the right. The menu is open, showing two options: Correctly crimped cable and Incorrectly crimped cable. The 'Correctly crimped cable' option is highlighted with a red border.

NEW QUESTION: 414

A network technician is troubleshooting a connectivity issue and determines the cause is related to the VLAN assignment on one of the access switches in the network. After resolving the issue, the network technician decides to update the documentation to refer to the correct VLAN. Which of the following should the technician update?

- A. Change management documentation
- B. IDF documentation
- C. Incident response plan
- D. Physical diagram
- E. Logical diagram

Answer: ([SHOW ANSWER](#))

NEW QUESTION: 415

A vulnerability that would allow an unauthenticated, remote attacker to originate a DoS attack was found in a DHCP client implementation of a switch. Which of the following would BEST resolve the issue?

- A. Verify the default passwords have been changed.
- B. Generate new SSH keys.
- C. Review and modify the firewall rules.
- D. Upgrade to the latest firmware

Answer: D ([LEAVE A REPLY](#))

NEW QUESTION: 416

Which of the following MUST be implemented to share metrics between routing protocols within the same router?

- A. Dynamic routes
- B. Routing loop
- C. Routing table
- D. Route redistribution

Answer: C ([LEAVE A REPLY](#))

NEW QUESTION: 417

The engineering department wants to bring a legacy computer online to test a failed component. When patching the device into the switch, there are no link lights or connectivity. The legacy computer can ping its loopback address successfully. Another device can connect to that same port without issues. Which of the following should the network technician check NEXT? (Choose two.)

- A. Duplex requirements
- B. Speed setting on the switch
- C. VLAN settings
- D. Protocols the legacy computer supports
- E. Firmware version
- F. Network card drivers

Answer: ([SHOW ANSWER](#))

NEW QUESTION: 418

A network administrator is deploying a new switch in an existing IDF. The current switch has only copper Ethernet ports available to use for the trunk ports. Which of the following cable types should the network administrator deploy?

- A. Straight-through

- B. Rollover
- C. Console
- D. Crossover

Answer: D ([LEAVE A REPLY](#))

NEW QUESTION: 419

An end-user device requires a specific IP address every time it connects to the corporate network; however, corporate policy does not allow the use of static IP addresses. Which of the following will allow the request to be fulfilled without breaking the corporate policy?

- A. DHCP option
- B. DHCP exclusion
- C. DHCP reservation
- D. DHCP relay

Answer: C ([LEAVE A REPLY](#))

NEW QUESTION: 420

A network engineer is trying to determine where to place a firewall based on the flow of traffic. Which of the following types of documentation would assist the engineer in doing this?

- A. Change management
- B. Rack diagram
- C. Network configuration
- D. Network diagram

Answer: ([SHOW ANSWER](#))

NEW QUESTION: 421

You have been tasked with testing a CAT5e cable. A summary of the test results can be found on the screen.

Step 1: Select the tool that was used to create the cable test results.

Step 2: Interpret the test results and select the option that explains the results. After you are done with your analysis, click the 'Submit Cable Test Analysis' button.

Cable Crimp

Instructions: You have determined that the original crimp is faulty using the T568B cabling standard. Drag the appropriate tool to the RJ-45 Connector. When you are finished, click the Done button.

Question:

You have been tasked with testing a CAT5e cable. A summary of the test results can be found on the screen.

Step 1: Select the tool that was used to create the cable test results.

Step 2: Interpret the test results and select the option that explains the results. After you are done with your analysis, click the "Submit Cable Test Analysis" button.

Done

Reset

Help

This window can be resized.

ATA Simulotica

RJ-45 Connector



Reset Cable

Cable Test

Step 1: Select the tool that was used to create the cable test results.

Cable Test Result			
1, 2	Open	7ft	
3, 6	Short	7ft	
4, 5	Open	7ft	
7, 8	Open	7ft	

→

Tool Choices	
<input type="checkbox"/>	Crimper
<input type="checkbox"/>	Cable Certifier
<input type="checkbox"/>	Multimeter
<input type="checkbox"/>	Punch Down Tool
<input type="checkbox"/>	Protocol Analyzer
<input type="checkbox"/>	OTDR
<input type="checkbox"/>	Toner Probe

CompTIA

Answer:

CompTIA
Cable Test

Step 1: Select the tool that was used to create the cable test results.

Cable Test Result			
1, 2	Open	7ft	
3, 6	Short	7ft	
4, 5	Open	7ft	
7, 8	Open	7ft	

Tool Choices

Crimper

Cable Certifier

Multimeter

Punch Down Tool

Protocol Analyzer

OTDR

Toner Probe

Step 2: Interpret the test results and select the option that explains the results.

After you are done with your analysis, click the 'Submit Cable Test Analysis' button.

Correctly crimped cable
 Incorrectly crimped cable

A Cable Certifier provides "Pass" or "Fail" information in accordance with industry standards but can also show detailed information when a "Fail" occurs. This includes shorts, the wire pairs involved and the distance to the short. When a short is identified, at the full length of the cable it means the cable has not been crimped correctly.

Valid N10-007 Dumps shared by PrepPdf.com for Helping Passing N10-007 Exam!
 PrepPdf.com now offer the **newest N10-007 exam dumps**, the PrepPdf.com N10-007 exam questions have been updated and answers have been corrected get the newest PrepPdf.com N10-007 dumps with Test Engine here:
<https://www.preppdf.com/CompTIA/N10-007-prepaway-exam-dumps.html> (690 Q&As Dumps, **40%OFF Special Discount: Exam-Tests**)

NEW QUESTION: 422

A junior network technician is setting up a new email server on the company network. Which of the following default ports should the technician ensure is open on the firewall so the new email server can

relay email?

- A. 143
- B. 25
- C. 110
- D. 23

Answer: B ([LEAVE A REPLY](#))

NEW QUESTION: 423

A vendor is installing an Ethernet network in a new hospital wing. The cabling is primarily run above the ceiling grid near air conditioning ducts and sprinkler pipes. Which of the following cable types is required for this installation'?

- A. Plenum
- B. Cat 7
- C. Single-mode
- D. PVC

Answer: A ([LEAVE A REPLY](#))

NEW QUESTION: 424

As part of a transition from a static to a dynamic routing protocol on an organization's internal network, the routing protocol must support IPv4 and VLSM. Based on those requirements, which of the following should the network administrator use? (Choose two.)

- A. IS-IS
- B. OSPF
- C. BGP
- D. RIPv1
- E. VRRP

Answer: A,B ([LEAVE A REPLY](#))

NEW QUESTION: 425

A network engineer planning for wireless connectivity in large office building. Currently, the office building contains both legacy and newer devices.

Which of the following wireless network routers should engineer select for the fastest throughput for all wireless devices in the office building?

- A. 802.11ac
- B. 802.11b
- C. 802.11g
- D. 802.11n

Answer: A ([LEAVE A REPLY](#))

Explanation

https://www.forbes.com/forbes/welcome/?
toURL=https://www.forbes.com/sites/gordonkelly/2014/12/30/802-11

NEW QUESTION: 426

A network administrator wishes to ensure there are no unnecessary open communication paths into a server. Using a port scanner, the administrator finds that ports are reported as closed. Which of the following BEST explains this response?

- A. The ports do not belong to a live system
- B. The ports replied with a SYN/ACK response
- C. The ports belong to an active system and are denying requests
- D. The ports are associated with deprecated services

Answer: D ([LEAVE A REPLY](#))

NEW QUESTION: 427

A development team has been testing a web server on a virtual server to create a web application. Once satisfied, the development team clones the entire virtual server into production. The development team needs to use HTTP, HTTPS, and SSH to connect to the new server. Which of the following should the network administrator do to help secure this new production VM? (Choose two.)

- A. Issue a new self-signed certificate.
- B. Remove unnecessary testing accounts.
- C. Generate new SSH host keys.
- D. Disable the HTTP port in the host firewall.
- E. Upgrade the firmware on the firewall.

Answer: A,C ([LEAVE A REPLY](#))

NEW QUESTION: 428

Lab Simulation

You have been tasked with testing a CAT5e cable. A summary of the test results can be found on the screen.

Cable Test Result		
1.2	open	7ft
3.6	short	7ft
4.5	open	7ft
7.8	open	7ft

Instructions:

Step 1: Select the tool that was used to create the cable test results.

Step 2: Interpret the test results and select the option that explains the results. After you are done with your analysis, click the 'Submit' button.

If at any time you would like to bring back the initial state of the simulation, please click the Reset All button.

Answer Area

Step 1 Select the tool that was used to create the cable test results

- Cable Certifier
- Punch Down Tool
- Crimper
- Toner Probe
- OTDR
- Multimeter
- Protocol Analyzer

Step 2 Interpret the test results and select the option that explains the results

- Correctly crimped cable
- Incorrectly crimped cable

Answer:

Answer Area

CompTIA

Step 1 Select the tool that was used to create the cable test results

- Cable Certifier
- Punch Down Tool
- Crimper
- Toner Probe
- OTDR
- Multimeter
- Protocol Analyzer

Step 2 Interpret the test results and select the option that explains the results

- Correctly crimped cable
- Incorrectly crimped cable

Explanation:

A Cable Certifier provides "Pass" or "Fail" information in accordance with industry standards but can also show detailed information when a "Fail" occurs. This includes shorts, the wire pairs involved and the distance to the short. When a short is identified, at the full length of the cable it means the cable has not been crimped correctly.

NEW QUESTION: 429

The security manager reports that individual systems involved in policy or security violations or incidents cannot be located quickly. The security manager notices the hostnames all appear to be randomly generated characters. Which of the following would BEST assist the security manager

identifying systems involved in security incidents?

- A. Enforce port security to require system authentication
- B. Implement a standardized UNC
- C. Label existing systems with current hostnames
- D. Forward the DHCP logs to the security manager every day

Answer: B ([LEAVE A REPLY](#))

Section: (none)

NEW QUESTION: 430

A administrator is troubleshooting a user's intermitted wireless connectivity issue. Other users across the hallway can connect use the wireless network properly. Upon inspection of the connection details, the administrator finds the following:

SSID	Company-WiFi
Signal	5%
SNR	2

Which of the following is MOST likely the cause of the poor wireless connection?

- A. Overcapacity
- B. Incorrect antenna type
- C. Channel overlap
- D. Latency

Answer: ([SHOW ANSWER](#)**)**

NEW QUESTION: 431

A home user is configuring a wireless router and must decide which wireless standard to use. The user has many devices that require a lot of bandwidth and must be able to communicate at a far distance from the router.

Which of the following wireless standards will BEST meet the home user's requirements?

- A. 802.11n
- B. 802.11g
- C. 802.11a
- D. 802.11b

Answer: ([SHOW ANSWER](#)**)**

NEW QUESTION: 432

Two WAPs are positioned with overlapping coverage, but seamless roaming across them is not working. Which of the following should be checked?

- A. WPA should be enabled
- B. PKI should be turned off
- C. WAPs are transmitting on same channel
- D. WAP SSIDs are matching

Answer: D ([LEAVE A REPLY](#))

NEW QUESTION: 433

A penetration tester has been tasked with reconnaissance to determine which ports are open on the network. Which of the following tasks should be done FIRST? (Choose two.)

- A. Network scan
- B. Banner grab
- C. Tracert
- D. DHCP server check
- E. Brute-force attack

Answer: A,C ([LEAVE A REPLY](#))

Section: (none)

NEW QUESTION: 434

Which of the following allow for higher fault tolerance, availability, and performance across multiple systems? (Select TWO).

- A. Clustering
- B. TCP offloading
- C. Jumbo frames
- D. Load balancer
- E. Round robin

Answer: B,D ([LEAVE A REPLY](#))

NEW QUESTION: 435

A network technician is installing and configuring a new router for the sales department. Once the task is complete, which of the following needs to be done to record the change the technician is making to the company network?

- A. Network diagrams
- B. Change management
- C. Labeling report
- D. Inventory report

Answer: ([SHOW ANSWER](#)**)**

NEW QUESTION: 436

A company has a DNS record for the following address: products.companyXYZ.com. The company would like to add another record, sales.companyXYZ.com, which continually points to the same IP address as products.companyXYZ.com. Which of the following DNS record would BEST accomplish this?

- A. PTR
- B. CNAME
- C. A
- D. MX
- E. AAAA

F. SRV

Answer: ([SHOW ANSWER](#))

Valid N10-007 Dumps shared by PrepPdf.com for Helping Passing N10-007 Exam!
PrepPdf.com now offer the **newest N10-007 exam dumps**, the PrepPdf.com N10-007 exam **questions have been updated** and **answers have been corrected** get the **newest** PrepPdf.com N10-007 dumps with Test Engine here:
<https://www.preppdf.com/CompTIA/N10-007-prepaway-exam-dumps.html> (**690** Q&As Dumps, **40%OFF** Special Discount: **Exam-Tests**)

NEW QUESTION: 437

Which of the following is the number of broadcast domain that are created when using an unmanaged 12- port switch?

- A. 12
- B. 0
- C. 6
- D. 2
- E. 1

Answer: E ([LEAVE A REPLY](#))

NEW QUESTION: 438

A company recently upgraded all of its printers to networked multifunction devices. Users can print to the new devices, but they would also like the ability to scan and fax files from their computers. Which of the following should the technician update to allow this functionality?

- A. NIC drivers
- B. Printer drivers
- C. Printer firmware
- D. Device software

Answer: ([SHOW ANSWER](#))

NEW QUESTION: 439

Two office buildings are connected via copper network cabling buried in the ground. During local construction, the second building suffers a permanent network outage. Which of the following are MOST likely the causes of the outage? (Select two.)

- A. Electromagnetic interference
- B. Open circuit
- C. Signal attenuation
- D. Crosstalk
- E. Short circuit

Answer: B ([LEAVE A REPLY](#))

NEW QUESTION: 440

A company's sales department is accustomed to sharing information with other organizations via FTP; however, FTP recently stopped working for the sales employees. Upon further review, it is determined a junior network technician recently applied an ACL without going through the proper change management process.

The network administrator found the following ACL:

```
ip access-list extended TEST-ACL-SALES-01
 10 remark "ALLOW USER ACCESS TO DHCP ETC"
 20 permit udp 0.0.0.0 255.255.255.255 host 10.2.1.2 eq 53
 30 permit udp 0.0.0.0 255.255.255.255 host 10.2.1.2 range 67 68
 40 remark "ALLOW USER ACCESS TO LDAP"
 50 permit tcp 0.0.0.0 255.255.255.255 host 10.2.4.28 eq 389
 60 permit tcp 0.0.0.0 255.255.255.255 host 10.2.4.28 eq 636
 70 remark "ALLOW USER ACCESS TO HTTPS"
 80 permit tcp 0.0.0.0 255.255.255.255 0.0.0.0 255.255.255.255 eq 80
 90 deny tcp 0.0.0.0 255.255.255.255 0.0.0.0 255.255.255.255 eq 443
100 remark "ALLOW USER ACCESS TO FTP"
110 allow tcp 0.0.0.0 255.255.255.255 0.0.0.0 255.255.255.255 eq 22
120 remark "DENY ALL OTHER TRAFFIC"
130 deny ip 0.0.0.0 255.255.255.255 0.0.0.0 255.255.255.255
```

Which of the following statement identifies the main issue?

- A. DNS needs to be allowed before FTP will work.
- B. An extended ACL is being used rather than a standard ACL.
- C. The ACL contains an incorrect port number.
- D. The ACL was applied incorrectly to the interface.

Answer: B ([LEAVE A REPLY](#))

NEW QUESTION: 441

A vulnerability that would allow an unauthenticated, remote attacker to originate a DoS attack was found in a DHCP client implementation of a switch. Which of the following would BEST resolve the issue?

- A. Upgrade to the latest firmware.
- B. Generate new SSH keys.
- C. Verify the default passwords have been changed.
- D. Review and modify the firewall rules.

Answer: A ([LEAVE A REPLY](#))

NEW QUESTION: 442

A network technician has recently installed new VoIP phones at all employees' desks to support a new SIP cloud solution. However, the technician is unable to make a call from the device after testing. Which of the following should the technician verify?

- A. TCP 8080 is allowed.

- B. UDP 1720 is allowed.
- C. TCP 8181 is allowed.
- D. UDP 5860 is allowed.
- E. UDP 5061 is allowed.
- F. TCP 433 is allowed.

Answer: ([SHOW ANSWER](#))

NEW QUESTION: 443

Which spare servers in the datacenter to mine bitcoins?

- A. AUP
- B. BYOD
- C. NDA
- D. MOU

Answer: ([SHOW ANSWER](#))

NEW QUESTION: 444

A request is made to open an additional port on a firewall. The request is approved, and the port is opened.

Which of the following BEST describes this process?

- A. Project management
- B. Standard operating procedure
- C. Process management
- D. Change management

Answer: D ([LEAVE A REPLY](#))

NEW QUESTION: 445

A network administrator has signed up for service with a new ISP. The administrator was given the IP address of 172.17.10.254/30 to use on the external interface of the Internet-facing router. However, the network administrator cannot reach the Internet using that address. Which of the following is the MOST likely explanation?

- A. The address provided by the ISP is the wrong one; they should be using 172.17.10.252/30.
- B. The address provided by the ISP has a mask that is too small to be used and needs a larger mask.
- C. The address provided by the ISP is part of the reserved loopback address space and cannot be used.
- D. The address provided by the ISP is a private IP address space and is not routable on the Internet.

Answer: ([SHOW ANSWER](#))

NEW QUESTION: 446

A user in the marketing department reports the email server is down. The user has not received

email for more than 24 hours. Which of the following should the network technician do to investigate this issue?

- A. Check the router and firewall to see if ACLs or firmware have changed in the last 24 hours.
- B. other users in the marketing department to see if they are also having connectivity issues.
- C. Check for network connectivity on the user's PC and reinstall the email client.
- D. Reboot the email server and verify connectivity once it is up again.

Answer: B ([LEAVE A REPLY](#))

NEW QUESTION: 447

In a service provider network, a company has an existing IP address scheme. Company A's network currently uses the following scheme:

```
Subnet 1: 192.168.1.0/26
Subnet 2: 192.168.1.65/26
```

Company b uses the following scheme:

Subnet 1: 192.168.1.50/28

The network administrator cannot force the customer to update its IP scheme. Considering this, which of the following is the BEST way for the company to connect these networks?

- A. DMZ
- B. NAT
- C. PAT
- D. VLAN

Answer: B ([LEAVE A REPLY](#))

NEW QUESTION: 448

After setting up In a temporary office, Joe tries to access the company's wireless network. Following several attempts, Joe is able to get an IP, but cannot access network resources. Which of the following is the MOST likely cause of this error when trying to connect to the compan/s wireless network?

- A. Incorrect passphrase
- B. Incorrect power levels
- C. Incorrect workstation certificate
- D. Incorrect encryption

Answer: C ([LEAVE A REPLY](#))

NEW QUESTION: 449

Drag and Drop Question

Under each network device, drag and drop the associated broadcast and/or collision description. Objects may be used multiple times, as needed.



Answer:

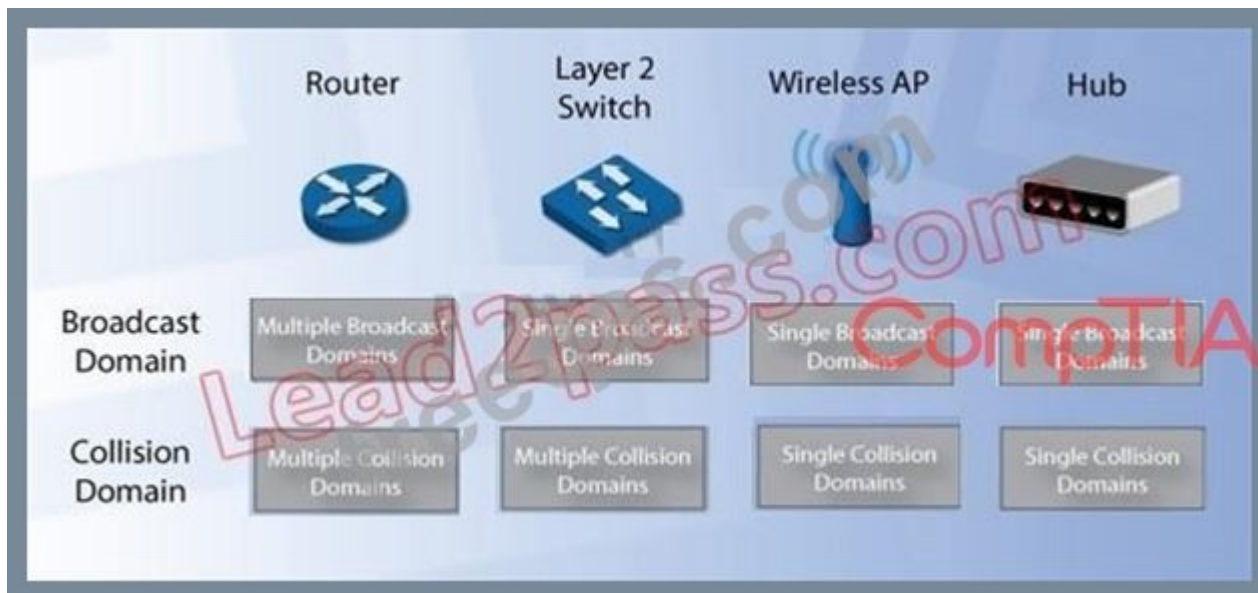

NEW QUESTION: 450

A network technician does not have access to the GUI of a server and needs to adjust some network properties. Given the command:

```
route add 0.0.0.0 mask 0.0.0.0 192.169.1.222 metric 1
```

Which of the following is the technician attempting to alter?

- A. The technician is clearing the subnet mas setting.
- B. The technician is clearing the route table.
- C. The technician is setting the default gateway.
- D. The technician is adding a static IP address.

Answer: C (LEAVE A REPLY)

NEW QUESTION: 451

The engineering department wants to bring a legacy computer online to test a failed component.

When patching the device into the switch, there are no link lights or connectivity. The legacy computer can ping its loopback address successfully. Another device can connect to that same port without issues. Which of the following should the network technician check NEXT? (Choose two.)

- A. Duplex requirements
- B. VLAN settings
- C. Speed setting on the switch
- D. Protocols the legacy computer supports
- E. Firmware version
- F. Network card drivers

Answer: E,F ([LEAVE A REPLY](#))

Valid N10-007 Dumps shared by PrepPdf.com for Helping Passing N10-007 Exam!
PrepPdf.com now offer the **newest N10-007 exam dumps**, the PrepPdf.com N10-007 exam **questions have been updated** and **answers have been corrected** get the **newest** PrepPdf.com N10-007 dumps with Test Engine here:
<https://www.preppdf.com/CompTIA/N10-007-prepaway-exam-dumps.html> (**690** Q&As Dumps, **40%OFF** Special Discount: **Exam-Tests**)

NEW QUESTION: 452

Which of the following physical security devices is used to prevent unauthorized access rto a datacenter?

- A. Smart card reader
- B. Motion detector
- C. Video camera
- D. Asset tracking

Answer: B ([LEAVE A REPLY](#))

NEW QUESTION: 453

A company is contracting a new third-party organization that will handle storage of the company's critical data. Which of the following policies would ensure the data remains confidential?

- A. BYOD
- B. MOU
- C. NDA
- D. SLA

Answer: C ([LEAVE A REPLY](#))

NEW QUESTION: 454

A network technician discovers there is no connectivity on a T1 line even though the cable connection appears to be in place. The router shows there is no active connection on the port.

The issue is occurring between the demarcation point and the router port. The router cable tests fine and is terminated at the demarcation panel. Which of the following tools should be used to fix the issue?

- A. Punchdown tool
- B. Crimper
- C. Loopback adapter
- D. OTDR

Answer: A ([LEAVE A REPLY](#))

NEW QUESTION: 455

A national cable company providing TV, telephone, and Internet service to home users over its IP network, has been tracking a large increase of network bandwidth due to P2P file sharing. Which of the following should the company deploy to ensure excellent TV and telephone service?

- A. High availability
- B. Fiber optics
- C. QoS
- D. Load balancing

Answer: C ([LEAVE A REPLY](#))

NEW QUESTION: 456

An employee, who is using a laptop connected to the wireless network. Is able to connect to the Internet but not to internal company resources. A systems administrator reviews the following information from the laptop:

```
IP: 192.168.1.100  
MASK: 255.255.255.0  
ROUTER: 192.168.1.1
```

The administrator was expecting to see a network address within 10.100.0.0/23, which is consistent with the company's wireless network. The network administrator verifies the company's wireless network is configured and working properly. Which of the following is the MOST likely cause of this issue?

- A. Interference
- B. Wrong SSID
- C. Security type mismatch
- D. channel overlap

Answer: ([SHOW ANSWER](#))

NEW QUESTION: 457

A network technician has discovered a rogue access point under an empty cubicle desk. Which of the following should the technician perform to ensure another cannot be placed on the network?

- A. Enable DHCP guard to detect rogue servers
- B. Disable unused ports on switches

C. Configure WPA2 on all access points

D. Use TACACS+ authentication

Answer: A ([LEAVE A REPLY](#))

NEW QUESTION: 458

A technician is responsible for configuring a new firewall. The hardware team has already installed, powered, and connected the system. Which of the following types of documentation should the technician utilize to complete the task?

A. IDF/MDF documentation

B. Logical and physical diagrams

C. Network performance baseline

D. Rack diagram

Answer: B ([LEAVE A REPLY](#))

NEW QUESTION: 459

A network technician notices the site-to site VPN and internet connection have back up at a branch office' after a recent power outage. Which of the following is an out-of-band method the technician the would MOST likely utilize to check the branch office's router status?

A. Use a modem to console into router.

B. Walk to the branch troubleshooting the connection.

C. Travel to the branch office.

D. Hire a contractor to go on-site.

Answer: B ([LEAVE A REPLY](#))

NEW QUESTION: 460

In a service provider network, a company has an existing IP address scheme. Company A's network currently uses the following scheme:

Subnet 1: 192.168.1.0/26

Subnet 2: 192.168.1.65/26

Company b uses the following scheme:

Subnet 1: 192.168.1.50/28

The network administrator cannot force the customer to update its IP scheme. Considering this, which of the following is the BEST way for the company to connect these networks?

A. DMZ

B. VLAN

C. NAT

D. PAT

Answer: C ([LEAVE A REPLY](#))

NEW QUESTION: 461

Users have been experiencing slow network response times, and management has asked the

network technician to provide evidence of network improvement. After optimizing the network, which of the following would be required?

- A. IDF/MDF documentation
- B. Change management
- C. Performance baseline
- D. Physical diagram

Answer: C ([LEAVE A REPLY](#))

Section: (none)

NEW QUESTION: 462

A network technician is segments network traffic into various broadcast domains. Which of the following should the network technician utilize?

- A. VLAN
- B. BPDU
- C. ACL
- D. STP

Answer: ([SHOW ANSWER](#)**)**

NEW QUESTION: 463

A wireless client is having issues staying connected to the wireless network even though the client is less than 20ft (6m) from the access point. Which if the following is MOST likely the cause?

- A. Latency
- B. Security type mismatch
- C. Distance limitations
- D. Absorption

Answer: D ([LEAVE A REPLY](#))

NEW QUESTION: 464

A SAN serves out storage to a company's virtual environment and provides low-level disk access. The company wants to use its existing IP network and equipment to access the virtual disks. Which of the following network connection types would BEST accomplish this task?

- A. InfiniBand
- B. iSCSI
- C. Fibre Channel
- D. CIFS

Answer: B ([LEAVE A REPLY](#))

NEW QUESTION: 465

A client moving into a new office wants the IP network set up to accommodate 412 network-connected devices that are all on the same subnet. The subnet needs to be as small as possible.

Which of the following subnet masks should be used to achieve the required result?

- A. 255.255.252.0
- B. 255.255.0.0
- C. 255.255.255.0
- D. 255.255.254.0

Answer: D (LEAVE A REPLY)

NEW QUESTION: 466

Lisa, a consultant, is inspecting an office that reports frequent wireless issues. Upon scanning the network broadcasting in the vicinity of the office, seven SSIDs are found. The company's Wi-Fi network and three others all share channel six. Which of the following is MOST likely causing the issue?

- A. Incorrect channel
- B. Standard mismatch
- C. Low signal strength
- D. Frequency interference

Answer: D (LEAVE A REPLY)

Valid N10-007 Dumps shared by PrepPdf.com for Helping Passing N10-007 Exam!
PrepPdf.com now offer the **newest N10-007 exam dumps**, the PrepPdf.com N10-007 exam **questions have been updated** and **answers have been corrected** get the **newest** PrepPdf.com N10-007 dumps with Test Engine here:
<https://www.preppdf.com/CompTIA/N10-007-prepaway-exam-dumps.html> (690 Q&As Dumps, **40%OFF Special Discount: Exam-Tests**)

NEW QUESTION: 467

You have been tasked with setting up a wireless network in an office. The network will consist of 3 Access Points and a single switch. The network must meet the following parameters:

INSTRUCTIONS

Click on the devices to review their information and adjust the settings of the APs to meet the given requirements.

If any time you would like to bring back the initial state of the simulation, please click the Reset All

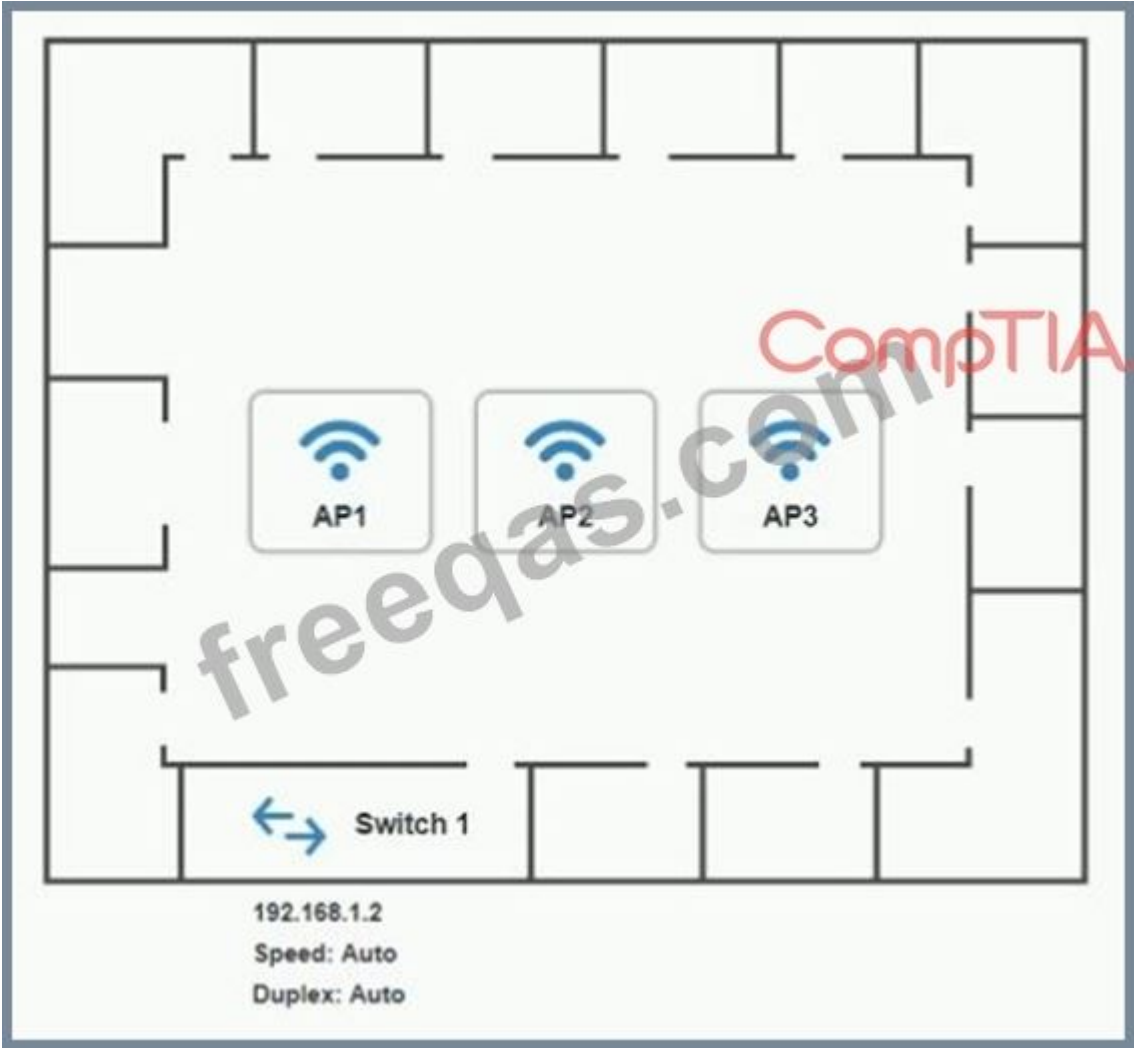

AP1 Configuration

https://ap1.setup.do

Basic Configuration

Access Point Name: AP1

IP Address: /

Gateway: 192.168.1.1

SSID:

SSID Broadcast: Yes No

Wireless

Mode:

Channel:

Wired

Speed: 100 1000 Auto

Duplex: Auto Half Full

AP1 Configuration

https://ap1.setup.do

Basic Configuration

Access Point Name: AP1

IP Address: 192.168.1.32 / 27

Gateway: 192.168.1.1

SSID: CorpNet

SSID Broadcast: Yes No

Wireless

Mode:

Channel:

Wired

Speed: 100 1000 Auto

Duplex: Auto Half Full

AP1 Configuration



https://ap1.setup.do

Basic Configuration

1		
2	Access Point Name	AP1
3		
4	IP Address	192.168.1.32 / 27
5	Gateway	192.168.1.1
6	SSID	CorpNet
7		
8	SSID Broadcast	<input checked="" type="radio"/> Yes <input type="radio"/> No
9		

Wireless

10		
11	Mode	
	Channel	

Wired

Speed	<input checked="" type="radio"/> 100 <input type="radio"/> 1000 <input type="radio"/> Auto
Duplex	<input type="radio"/> Auto <input type="radio"/> Half <input checked="" type="radio"/> Full

Cancel

Save

AP2 Configuration

https://ap2.setup.do

Basic Configuration

Access Point Name: AP2

IP Address: 192.168.1.64 / 27

Gateway: 192.168.1.1

SSID: CorpNet

SSID Broadcast: Yes No

Wireless

Mode: [Dropdown]

Channel: [Dropdown]

Wired

Speed: 100 1000 Auto

Duplex: Auto Half Full

AP2 Configuration

https://ap2.setup.do

Basic Configuration

1

2

Access Point Name: AP2

3

4

IP Address: 192.168.1.64 / 27

5

Gateway: 192.168.1.1

6

SSID: CorpNet

7

8

SSID Broadcast: Yes No

9

Wireless

10

11

Mode: [Dropdown]

Channel: [Dropdown]

Wired

Speed: 100 1000 Auto

Duplex: Auto Half Full

AP3 Configuration



https://ap3.setup.do

Basic Configuration

Access Point Name

AP3

IP Address

Gateway

192.168.1.1

SSID

SSID Broadcast

Yes No

Wireless

Mode

Channel

Wired

Speed

100 1000 Auto

Duplex

Auto Half Full

Cancel

Save

AP3 Configuration



https://ap3.setup.do

Basic Configuration

Access Point Name

AP3

IP Address

192.168.1.96

/ 27

Gateway

192.168.1.1

SSID

CorpNet

SSID Broadcast

Yes No

Wireless

Mode

Channel

B

G

Wired

Speed

100 1000 Auto

Duplex

Auto Half Full

Cancel

Save

The screenshot shows the 'AP3 Configuration' web interface. The browser address bar displays 'https://ap3.setup.do'. The 'Basic Configuration' section includes a table with 11 rows and two columns. The first column lists configuration items, and the second column shows their current values. Below this table are 'Wireless' and 'Wired' sections. The 'Wireless' section has 'Mode' and 'Channel' dropdown menus. The 'Wired' section has 'Speed' and 'Duplex' radio button options. At the bottom are 'Cancel' and 'Save' buttons.

Item	Value
1	
2	AP3
3	192.168.1.96 / 27
4	
5	192.168.1.1
6	CorpNet
7	<input checked="" type="radio"/> Yes <input type="radio"/> No
8	
9	
10	
11	

Wireless

Mode: [Dropdown]

Channel: [Dropdown]

Wired

Speed: 100 1000 Auto

Duplex: Auto Half Full

Buttons: Cancel, Save

Answer:

On the first exhibit, the layout should be as follows

Access Point Name AP1

IP Address 192. 168. 1. 3

Gateway 192. 168. 1. 2

SSID corpnet

SSID Broadcast yes

Mode G

Channel 1

Speed Auto

Duplex Auto

WPA

Passphrase S3cr3t!

Exhibit 2 as follows

Access Point Name AP2

IP Address 192. 168. 1. 4

Gateway 192. 168. 1. 2

SSID corpnet

SSID Broadcast yes

Mode G

Channel 6

Speed Auto

Duplex Auto

WPA

Passphrase S3cr3t!
Exhibit 3 as follows
Access Point Name AP3
IP Address 192. 168. 1. 5
Gateway 192. 168. 1. 2
SSID corpnet
SSID Broadcast yes
Mode G
Channel 11
Speed Auto
Duplex Auto
WPA
Passphrase S3cr3t!

NEW QUESTION: 468

A network technician is troubleshooting an issue and has established a theory of probable cause. Which of the following steps should the network technician take NEXT?

- A. Determine what has changed
- B. Question the users
- C. Test the possible solution
- D. Document the theory

Answer: C ([LEAVE A REPLY](#))

NEW QUESTION: 469

A network administrator is investigating an issue with VoIP calls that are not establishing properly. After troubleshooting, the administrator is able to determine the SIP responses are not being received by the gateway.

Which of the following did the administrator use to determine this information?

- A. tracer
- B. netstat
- C. A packet analyzer
- D. A spectrum analyzer

Answer: C ([LEAVE A REPLY](#))

NEW QUESTION: 470

Client PCs are unable to receive addressing information from a newly configured interface on a router.

Which of the following should be added to allow the clients to connect?

- A. TTL
- B. DNS record type
- C. DHCP lease me

D. IP helper

Answer: D ([LEAVE A REPLY](#))

NEW QUESTION: 471

A network technician has deployed a new 802.11ac network and discovers some of the legacy POS equipment only supports WPA and 802.11a. Which of the following is the MOST secure method of connecting all devices while avoiding a performance impact to modern wireless devices?

- A. Create two SSIDs, one to support CCMP-AES encryption and one with TKIP-RC4 encryption.
- B. Configure modern devices under the 5GHz band while dedicating the 2.4GHz band to legacy devices.
- C. Configure the APs to use LEAP authentication to support WPA rather than WPA2 for full compatibility.
- D. Connect the legacy devices with a PSK while the modern devices should use the more secure EAP.

Answer: D ([LEAVE A REPLY](#))

NEW QUESTION: 472

A university has a lecture hall containing 100 students. Currently, the lecture hall has two 802.11ac wireless access points, which can accommodate up to 50 devices each. Several students report they are unable to connect devices to the wireless network. Which of the following is MOST likely the issue?

- A. The students are using more than one wireless device port seat.
- B. The students are attempting to connect 802.11g devices
- C. One of the wireless access points is on the wrong frequency
- D. Distance limitations are preventing the students from connecting.

Answer: D ([LEAVE A REPLY](#))

NEW QUESTION: 473

A network technician is troubleshooting an issue and has established a theory of probable cause. Which of the following steps should the network technician take NEXT?

- A. Test the possible solution
- B. Question the users
- C. Determine what has changed
- D. Document the theory

Answer: A ([LEAVE A REPLY](#))

Section: (none)

NEW QUESTION: 474

Which of the following concepts would MOST likely be used to identify individual pieces of hardware throughout their life cycle?

- A. Asset tagging
- B. Geofencing
- C. Smart locker
- D. Chain of custody

Answer: C ([LEAVE A REPLY](#))

NEW QUESTION: 475

Ann. a user, reports that her desktop phone is not working on one cable. However, that cable provides connectivity to her laptop. A technician determines PoE is not provided to the end device. Which of the following is MOST likely the cause?

- A. Jitter
- B. Crosstalk
- C. Transceiver mismatch
- D. Open/short on the cable

Answer: C ([LEAVE A REPLY](#))

NEW QUESTION: 476

A customer has submitted a request for a new wireless connection In the main office so visitors can reach the Internet to check their email. The customer is concerned about security and does not want visitors to be able to access the internal finance server. Which of the following BEST describes the correct configuration?

- A. The LAN and WLAN should be configured in the DMZ so traffic is denied automatically.
- B. The LAN and WLAN should be marked as trusted during work hours and untrusted during off hours.
- C. The LAN and WLAN should be configured In the same zone with dynamic DENY ALL rules.
- D. The LAN and WLAN should be configured In separate zones with a firewall in between.

Answer: ([SHOW ANSWER](#))

NEW QUESTION: 477

Which of the following cables will MOST likely be used to connect to a satellite dish?

- A. Fiber
- B. CAT6
- C. CAT5e
- D. RG-6

Answer: D ([LEAVE A REPLY](#))

NEW QUESTION: 478

Which of the following will prevent switching loops by selectively shutting down switch ports?

- A. RIP
- B. VLAN
- C. IGP

D. STP

Answer: D ([LEAVE A REPLY](#))

NEW QUESTION: 479

A technician is upgrading the firmware on an older KVM switch. The specifications call for a serial port to connect to the computer on one side, and an Ethernet jack to connect to the switch on the other side.

Which of the following connectors does the technician need for this cable? (Choose two.)

A. RJ-11

B. BNC

C. DB-25

D. RJ-45

E. DB-9

F. RG-9

Answer: D,E ([LEAVE A REPLY](#))

NEW QUESTION: 480

Due to regulatory requirements, a college bookstore prohibits customers from accessing the wireless network in the building. Which of the following would be the BEST method to prevent customers from accessing the wireless network while in the bookstore?

A. Use MAC filtering for authorization to the wireless network.

B. Require PEAP for authentication to the wireless network.

C. Implement a Faraday cage within the bookstore premises.

D. Require a pre-shared key for authentication to the wireless network.

Answer: C ([LEAVE A REPLY](#))

Explanation/Reference:

NEW QUESTION: 481

A building is equipped with light sensors that turn off the fluorescent lights when natural light is above a certain brightness. Users report experiencing network connection issues only during certain hours. The west side of the building experiences connectivity issues in the morning hours and the east side near the end of the day. At night the connectivity issues affect the entire building. Which of the following could be the cause of the connectivity issues?

A. Light sensors are interfering with the network

B. EMI from the lights is interfering with the network cables

C. Network wiring is run perpendicular to electrical conduit

D. Temperature changes are causing attenuation in copper cabling

Answer: C ([LEAVE A REPLY](#))

Section: (none)

Valid N10-007 Dumps shared by PrepPdf.com for Helping Passing N10-007 Exam!
PrepPdf.com now offer the **newest N10-007 exam dumps**, the PrepPdf.com N10-007 exam **questions have been updated** and **answers have been corrected** get the **newest** PrepPdf.com N10-007 dumps with Test Engine here:
<https://www.preppdf.com/CompTIA/N10-007-prepaway-exam-dumps.html> (690 Q&As Dumps, **40%OFF Special Discount: Exam-Tests**)

NEW QUESTION: 482

A company has attempted to introduce a new major network segment to allow growth in capacity. On the core switch, a GBIC was used to interconnect with a newly placed downstream distribution switch for the first time.

Soon after this implementation, a network flood and an outage occurred between the core and new distribution network modules. Which of the following should the network administrator troubleshoot FIRST in order to rectify the issue?

- A. Check for inconsistent or missing routes between the core and distribution switches.
- B. Check whether the GBIC was set to multi-mode instead of single-mode SFP.
- C. Check whether an incorrect VLAN has been assigned to the new distribution switch.
- D. Check for switching loops between core and distribution switches.

Answer: D ([LEAVE A REPLY](#))

NEW QUESTION: 483

A network technician is assisting a SOHO environment with wireless connection issues. The business uses 802.11n and WPA2 encryption. The on-premises equipment is located toward the back of the building and includes a router, firewall, and WAP. The users at the front of the building are experiencing very slow response times due to distance limitations. Which of the following should be done to remediate the slow speeds of the users?

- A. Remove the channel overlap.
- B. Add another AP.
- C. Adjust the security type.
- D. Configure MIMO.

Answer: B ([LEAVE A REPLY](#))

NEW QUESTION: 484

A network technician has deployed a new 802.11ac network and discovers some of the legacy POS equipment only supports WPA and 802.11a. Which of the following is the MOST secure method of connecting all devices while avoiding a performance impact to modern wireless devices?

- A. Connect modern devices under the 5GHz band while dedicating the 2.4GHz band to legacy devices.
- B. Configure the APs to use LEAP authentication to support WPA rather than WPA2 for full compatibility.

C. Connect the legacy devices with a PSK while the modern devices should use the more secure EAP

D. Create two SSIDs. one to support CCMP-AES encryption and one with TKIP-RC4 encryption.

Answer: D ([LEAVE A REPLY](#))

NEW QUESTION: 485

A network technician is assisting a user who is experiencing connectivity problems with the VPN. The technician has confirmed the VPN is functioning and other users at the site cannot access the Internet. Which of the following commands would MOST likely be used to further troubleshoot?

A. dig

B. netstat

C. arp

D. tracer

Answer: D ([LEAVE A REPLY](#))

NEW QUESTION: 486

A network engineer at a large company is restricting Internet browsing on the corporate WAN to only business-related external websites. Which of the following is the BEST solution to achieve this goal while avoiding the need to configure this restriction on each PC?

A. IPS

B. Web application firewall

C. Content filter

D. VPN concentrator

Answer: C ([LEAVE A REPLY](#))

NEW QUESTION: 487

A network administrator is redesigning network security after an attack. During the attack, an attacker used open cubicle locations to attach devices to the network. The administrator wants to be able to monitor future attacks in a safe environment and determine the method of attack. Which of the following should the administrator do to BEST meet this requirement?

A. Create a VLAN for the unused ports and create a honeypot on the VLAN.

B. Install antivirus software and set an ACL on the servers.

C. Install a BPDU guard on switchports and enable STP.

D. Create a DMZ for public servers and secure a segment for the internal network.

Answer: ([SHOW ANSWER](#))

NEW QUESTION: 488

After rebooting a PC, a user is no longer able to connect to the corporate network. As a test the technician plugs a different laptop into the same network jack and receives an IP address of 169.254.112.137. Which of the following is MOST likely causing the issue?

- A. Improper DNS setting
- B. Incorrect ACL setting
- C. DHCP scope exhaustion
- D. Port-security violation

Answer: ([SHOW ANSWER](#))

NEW QUESTION: 489

A technician is troubleshooting a problem with a network printer. The technician thinks the network printer is out of paper and ink. Which of the following should the technician do NEXT?

- A. Test the theory
- B. Question users
- C. Implement the solution
- D. Escalate the problem

Answer: A ([LEAVE A REPLY](#))

NEW QUESTION: 490

A user calls the help desk for assistance with setting up a new SOHO router. The user has three employees who all have laptops that need to connect to the wireless network. The users need to have firewall rules allowing access to an internal server, but cannot be configured with static IP addresses. Which of the following BEST describes what the technician should implement?

- A. CNAME record in the users' dynamic DNS accounts
- B. Additional lease time for the laptop computers
- C. IP helper relay system for configuration hops
- D. DHCP reservation for the laptops' MACs

Answer: ([SHOW ANSWER](#))

Explanation/Reference:

NEW QUESTION: 491

Which of the following is the physical location where the customer-premise equipment comes together with the ISP or third-party telecommunications equipment?

- A. Equipment closet
- B. Server room
- C. Intermediate distribution frame
- D. Demarcation point

Answer: ([SHOW ANSWER](#))

NEW QUESTION: 492

Lisa, a network administrator, needs to allow all websites to be accessible by the sales team for business purposes. Which of the following ports need to be enabled on the firewall? (Select TWO).

- A. 25

- B. 23
- C. 80
- D. 443
- E. 53

Answer: C,D ([LEAVE A REPLY](#))

NEW QUESTION: 493

In a service provider network, a company has an existing IP address scheme. Company A's network currently uses the following scheme:

Subnet 1: 192.168.1.0/26

Subnet 2: 192.168.1.65/26

Company b uses the following scheme:

Subnet 1: 192.168.1.50/28

The network administrator cannot force the customer to update its IP scheme. Considering this, which of the following is the BEST way for the company to connect these networks?

- A. PAT
- B. NAT
- C. VLAN
- D. DMZ

Answer: B ([LEAVE A REPLY](#))

NEW QUESTION: 494

Am cloud user at an internet cafe tries to visit online retailers website; however, the website for a computer loads. The user checks the URL in the address bar and verifies. it is connect, but the still loads. Which of the following BEST describes what is occurring?

- A. DNS poisoning
- B. Session hijacking
- C. Man in the middle
- D. Cross-site scripting

Answer: ([SHOW ANSWER](#))

NEW QUESTION: 495

Which of the following is the unit used to transfer information at Layer 2 of the OSI model?

- A. Session
- B. Socket
- C. Packet
- D. Frame

Answer: D ([LEAVE A REPLY](#))

NEW QUESTION: 496

A network administrator would like to collect information from several networking devices using

SNMP.

Which of the following SNMP options should a network administrator use to ensure the data transferred is confidential?

- A. authpriv
- B. SHA
- C. MD5
- D. Authentication passphrase

Answer: A ([LEAVE A REPLY](#))

Section: (none)

Valid N10-007 Dumps shared by PrepPdf.com for Helping Passing N10-007 Exam!
PrepPdf.com now offer the **newest N10-007 exam dumps**, the PrepPdf.com N10-007 exam **questions have been updated** and **answers have been corrected** get the **newest** PrepPdf.com N10-007 dumps with Test Engine here:
<https://www.preppdf.com/CompTIA/N10-007-prepaway-exam-dumps.html> (**690** Q&As Dumps, **40%OFF** Special Discount: **Exam-Tests**)

NEW QUESTION: 497

Which of the following is based ENTIRELY on using ICMP packets?

- A. Buffer overflow attack
- B. NMAP
- C. Smurf attack
- D. Social engineering

Answer: C ([LEAVE A REPLY](#))

NEW QUESTION: 498

A network technician is able to connect the switches between to offices, but the offices cannot communicate with each other, as each office uses a different IP addressing scheme. Which of the following devices needs to be installed between the switches to allow communication?

- A. Bridge
- B. Access point
- C. Range extender
- D. Router

Answer: D ([LEAVE A REPLY](#))

NEW QUESTION: 499

Zach, a technician, wants to test a laptop's NIC for functionality but has no other networking equipment to attach it to.

Which of the following would allow him to test basic functionality of the NIC?

- A. Protocol analyzer
- B. Smart jack
- C. Coupler
- D. Loopback plug

Answer: D ([LEAVE A REPLY](#))

NEW QUESTION: 500

At which of the following layers of the OSI model would TCP UDP operate?

- A. Layer 4
- B. Layer 5
- C. Layer 6
- D. Layer 3

Answer: A ([LEAVE A REPLY](#))

NEW QUESTION: 501

Which of the following components acts as an intermediary device between the internal user's PC and external web servers to provide caching services that save on internet bandwidth resources?

- A. Load balancer
- B. Firewall
- C. IDS
- D. Proxy server

Answer: B ([LEAVE A REPLY](#))

NEW QUESTION: 502

Which of the following protocols is used for remote management of devices?

- A. SMTP
- B. SNMP
- C. Syslog
- D. TFTP

Answer: B ([LEAVE A REPLY](#))

NEW QUESTION: 503

A company has a large number of employees that need VPN access from home. Which of the following is the BEST solution for deploying and managing the remote access?

- A. SSL VPN
- C. Site-to-site VPN
- B. Host-based firewall
- D. Network-based firewall

Answer: A ([LEAVE A REPLY](#))

Valid N10-007 Dumps shared by PrepPdf.com for Helping Passing N10-007 Exam!

PrepPdf.com now offer the **newest N10-007 exam dumps**, the PrepPdf.com N10-007 exam **questions have been updated** and **answers have been corrected** get the **newest** PrepPdf.com N10-007 dumps with Test Engine here:

<https://www.preppdf.com/CompTIA/N10-007-prepaway-exam-dumps.html> (690 Q&As Dumps,

40%OFF Special Discount: Exam-Tests)